

Module for emergency stops, end position monitoring for movable guards, OSSD semiconductor outputs and magnetic safety sensors

Main features

- For safety applications up to SIL 3/PL e
- Inputs: 1 or 2 channels, which can be connected to electromechanical contacts, magnetic safety sensors or OSSD solid-state outputs
- Outputs: relay, 2NO safety, 1NC signalling
- Input with configurable start: automatic, manual or monitored
- Supply voltage: 10 ... 30 Vdc, 24 Vac/dc, 120 Vac, 230 Vac

Quality marks:



EC type examination certificate: IMQ CP 432 DM

UL approval: E131787

CCC approval: 2024010305656748

EAC approval: RU D-T.PA07.B.37848/24

Compliance with the requirements of:

Machinery Directive 2006/42/EC,

EMC Directive 2014/30/EU,

RoHS Directive 2011/65/EU.

In compliance with standards:

EN 60204-1, EN ISO 13855, EN ISO 14118,
EN ISO 12100, EN ISO 13850, EN 60529, EN 61000-6-2,
EN 61000-6-3, EN 61326-1, EN 60664-1, EN 60947-1,
EN IEC 63000, EN ISO 13849-1, EN ISO 13849-2,
EN 62061, UL 508, CSA C22.2 No. 14, GB/T14048.5

Technical data

Housing

Polyamide housing PA 66, self-extinguishing V0 acc. to UL 94

Protection degree acc. to EN 60529:

IP40 (housing), IP20 (terminal strip)

Dimensions:

see page 135, design A

General data

Safety Integrity Level (SIL) up to:

Maximum SIL 3 acc. to EN 62061

Performance Level (PL) up to:

PL e acc. to EN ISO 13849-1

Safety category up to:

cat. 4 acc. to EN ISO 13849-1

Safety parameters:

See page 151

Ambient temperature:

-25°C...+55°C

Mechanical endurance:

> 10 million operating cycles

Electrical endurance:

> 100,000 operating cycles

Pollution degree:

external 3, internal 2

Rated impulse withstand voltage (U_{imp}):

4 kV

Rated insulation voltage (U_i):

250 V

Overvoltage category:

II

Power supply

Rated supply voltage (U_n):

10 ... 30 Vdc

24 Vac/dc; 50...60 Hz

120 Vac/dc; 50 ... 60 Hz

230 Vac/dc; 50 ... 60 Hz

Max. DC residual ripple in DC:

10%

Supply voltage tolerance:

-10% ... +15% of U_n for 24 Vac/dc

$\pm 15\%$ of U_n for 120 Vac, 230 Vac

< 5 VA

Power consumption AC:

< 2 W, < 3 W (CS AR-01•E02)

Power consumption DC:

Control circuit

Protection against short circuits:

PTC resistance, $I_h=0.5 A$

PTC times:

response > 100 ms, reset > 3 s

Maximum resistance per input:

$\leq 50 \Omega$

Current per input:

30 mA (typical)

Min. duration of start impulse t_{MIN} :

> 100 ms, > 50 ms (E02)

Response time t_A :

< 300 ms, < 150 ms (E02)

Release time t_{R1} :

< 20 ms

Release time in absence of power supply t_{R2} :

< 70 ms, < 100 ms (E02)

Simultaneity time t_C :

unlimited

Output circuit

Output contacts:

2 NO safety contacts,

1 NC auxiliary contact

forcibly guided

Contact type:

silver alloy

Material of the contacts:

230/240 Vac; 300 Vdc

Maximum switching voltage:

AC-15 (50 ... 60 Hz), 230 V / 3 A

Utilization categories for output contacts:

DC-13 (6 oper. cycles/min.), 24 V / 4 A

Maximum conventional free air thermal current per branch I_{th} :

6 A

Max. total current ΣI_{th}^2 :

72 A²

Minimum current:

10 mA

Contact resistance:

$\leq 100 m\Omega$

External protection fuse:

4 A

The number and the load capacity of output contacts can be increased by using expansion modules

or contactors. See pages 75-84.

Code structure

CS AR-01V024

Connection type	
V	Screw terminals
M	Connector with screw terminals
X	Connector with spring terminals

Supply voltage	
024	24 Vac/dc
120	120 Vac
230	230 Vac
E02	10 ... 30 Vdc

Features approved by UL

Rated supply voltage (U_n):

10 ... 30 Vdc

24 Vac/dc; 50...60 Hz

120 Vac; 50...60 Hz

230 Vac; 50...60 Hz

Power consumption AC:

< 5 VA

Power consumption DC:

< 4 W

Electrical ratings:

- NO contacts: 230/240 Vac, 6 A general use, C300 pilot duty

- NC contacts: 230/240 Vac, 6 A resistive, B300 pilot duty

Notes:

- Use 60 or 75°C copper (Cu) conductor and wire size No. 30-12 AWG, stranded or solid.
- The terminal tightening torque of 5-7 lb in.

- Only for 10 ... 30 Vdc and 24 Vac/dc versions: supply from remote Class 2 source or limited voltage limited energy.

- Utiliser des conducteurs en cuivre (Cu) 60 ou 75°C rigides ou flexibles de section 30-12 AWG.

- Couple de serrage des bornes de 5-7 Lb In.

- Seulement pour les versions 10 ... 30 Vdc et 24 Vac/dc, alimenter avec sources de classes 2 ou avec tension limitée et énergie limitée.



Safety module CS AR-01

Pin assignment

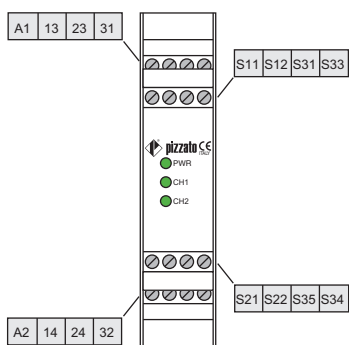

Internal wiring diagram

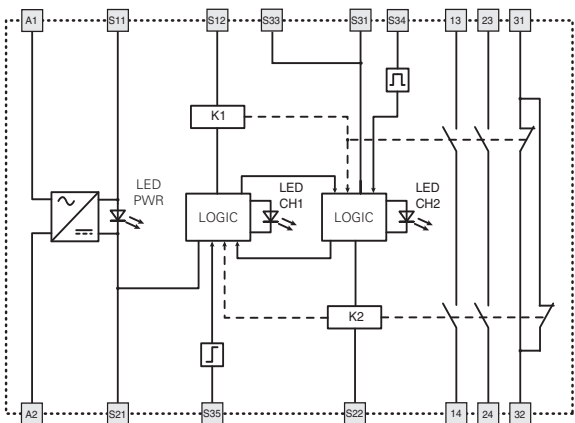

Input configuration

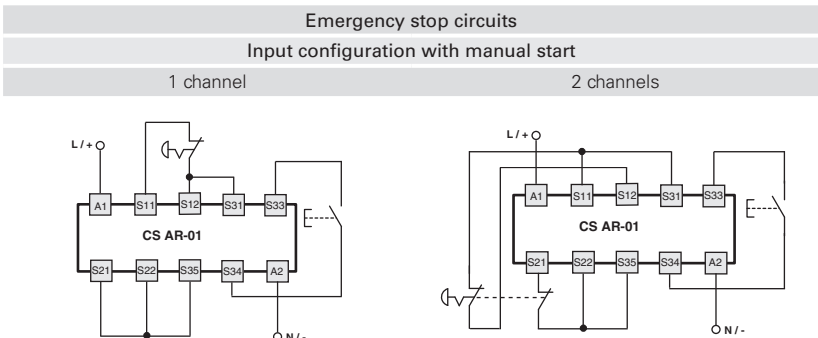
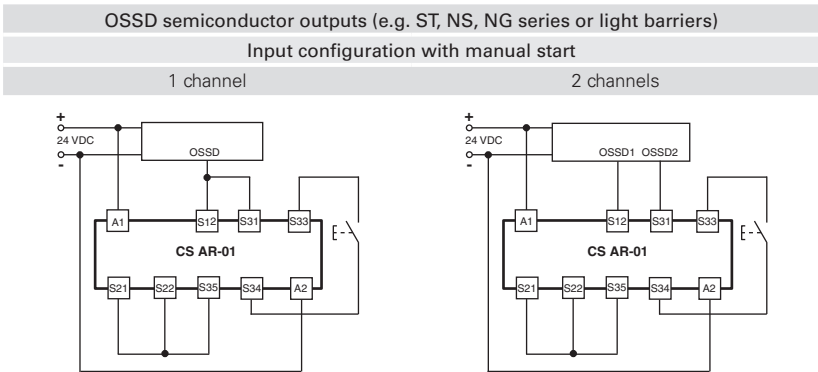

The diagram does not show the exact position of the terminals in the product

Function diagrams

Configuration with automatic start

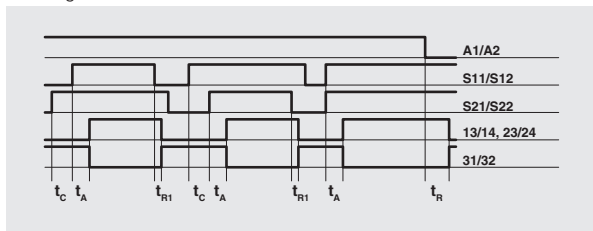

Configuration with monitored start

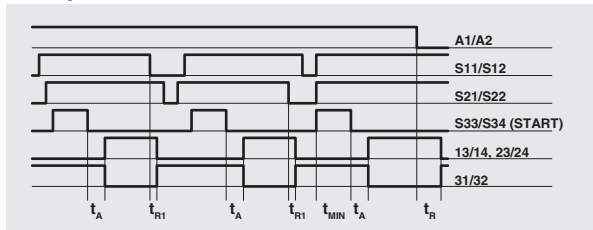

Configuration with manual start

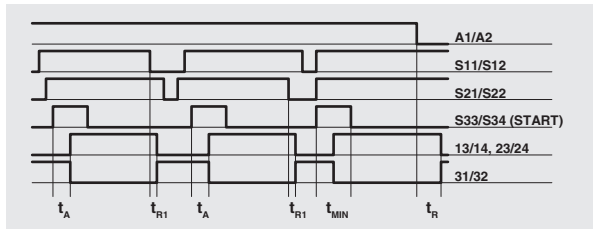

- Legend:
- t_{MIN} : Min. duration of start impulse
 - t_C : Simultaneity time
 - t_A : Response time
 - t_{R1} : Release time
 - t_{R2} : Release time in absence of power supply

Notes:
The configurations with one channel are obtained taking into consideration the S11/S12 input only. In this case it is necessary to consider time t_{R1} referred to input S11/S12, time t_R referred to the supply, time t_A referred to input S11/S12 and to the start, and time t_{MIN} referred to the start.

Automatic start

With regard to the indicated diagrams, bridge the start button between S33 and S34 in order to activate the automatic start module.

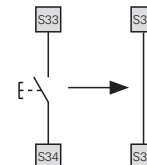

Monitored start

With regard to the indicated diagrams, remove the connection between the S22 and S35 terminals in order to activate the monitored start module.

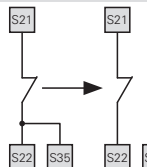

Monitoring of movable guards and magnetic safety sensors

The safety module can monitor emergency stop circuits, control circuits for movable guards as well as magnetic safety sensors. Replace the emergency stop contacts with switch contacts or sensor contacts. The sensors can only be used in 2-channel configuration.

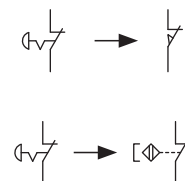

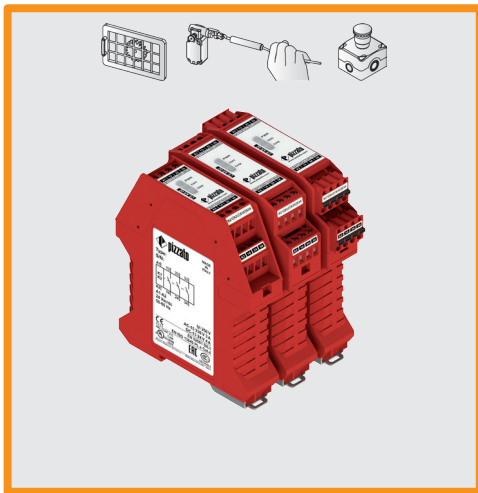

Module for emergency stops, end position monitoring for movable guards, OSSD semiconductor outputs and magnetic safety sensors

Main features

- For safety applications up to SIL 3/PL e
- Inputs: 1 or 2 channels, which can be connected to electromechanical contacts, magnetic safety sensors or OSSD solid-state outputs
- Outputs: relay, 3NO safety
- Input with configurable start: automatic, manual or monitored
- Supply voltage: 10 ... 30 Vdc, 24 Vac/dc, 120 Vac, 230 Vac

Quality marks:



EC type examination certificate: IMQ CP 432 DM
 UL approval: E131787
 CCC approval: 2024010305656748
 EAC approval: RU Д-IT.PA07.B.37848/24

Compliance with the requirements of:

Machinery Directive 2006/42/EC,
 EMC Directive 2014/30/EU,
 RoHS Directive 2011/65/EU.

In compliance with standards:

EN 60204-1, EN ISO 13855, EN ISO 14118,
 EN ISO 12100, EN ISO 13850, EN 60529, EN 61000-6-2,
 EN 61000-6-3, EN 61326-1, EN 60664-1, EN 60947-1,
 EN IEC 63000, EN ISO 13849-1, EN ISO 13849-2,
 EN 62061, UL 508, CSA C22.2 No. 14, GB/T14048.5

Technical data

Housing

Polyamide housing PA 66, self-extinguishing V0 acc. to UL 94
 Protection degree acc. to EN 60529: IP40 (housing), IP20 (terminal strip)
 Dimensions: see page 135, design A

General data

Safety Integrity Level (SIL) up to: Maximum SIL 3 acc. to EN 62061
 Performance Level (PL) up to: PL e acc. to EN ISO 13849-1
 Safety category up to: cat. 4 acc. to EN ISO 13849-1
 Safety parameters: See page 151
 Ambient temperature: -25°C...+55°C
 Mechanical endurance: >10 million operating cycles
 Electrical endurance: >100,000 operating cycles
 Pollution degree: external 3, internal 2
 Rated impulse withstand voltage (U_{imp}): 4 kV
 Rated insulation voltage (U_i): 250 V
 Overvoltage category: II

Power supply

Rated supply voltage (U_n): 10 ... 30 Vdc
 24 Vac/dc; 50...60 Hz
 120 Vac/dc; 50 ... 60 Hz
 230 Vac/dc; 50 ... 60 Hz
 Max. DC residual ripple in DC: 10%
 Supply voltage tolerance: -10% ... +15% of U_n for 24 Vac/dc
 ±15% of U_n for 120 Vac, 230 Vac
 Power consumption AC: < 5 VA
 Power consumption DC: < 2 W, < 3 W (CS AR-02•E02)

Control circuit

Protection against short circuits: PTC resistance, $I_h=0.5$ A
 response > 100 ms, reset > 3 s
 PTC times:
 Maximum resistance per input: ≤ 50 Ω
 Current per input: < 30 mA
 Min. duration of start impulse t_{MIN} : > 100 ms, > 50 ms (E02)
 Response time t_A : < 300 ms, < 150 ms (E02)
 Release time t_{R1} : < 20 ms
 Release time in absence of power supply t_{R2} : < 70 ms, < 100 ms (E02)
 Simultaneity time t_C : unlimited

Output circuit

Output contacts: 3 NO safety contacts, forcibly guided
 Contact type: silver alloy
 Material of the contacts:
 Maximum switching voltage: 230/240 Vac; 300 Vdc
 Utilization categories for output contacts: AC-15 (50 ... 60 Hz), 230 V / 3 A
 DC-13 (6 oper. cycles/min.), 24 V / 4 A
 Maximum conventional free air thermal current per branch I_{th} : 6 A
 Max. total current ΣI_{th}^2 : 72 A²
 Minimum current: 10 mA
 Contact resistance: ≤ 100 mΩ
 External protection fuse: 4 A

The number and the load capacity of output contacts can be increased by using expansion modules or contactors. See pages 75-84.

Code structure

CS AR-02V024

Connection type	
V	Screw terminals
M	Connector with screw terminals
X	Connector with spring terminals

Supply voltage	
024	24 Vac/dc
120	120 Vac
230	230 Vac
E02	10 ... 30 Vdc

Features approved by UL

Rated supply voltage (U_n): 10 ... 30 Vdc
 24 Vac/dc; 50...60 Hz
 120 Vac; 50...60 Hz
 230 Vac; 50...60 Hz
 Power consumption AC: < 5 VA
 Power consumption DC: < 4 W
 Electrical ratings:
 - NO contacts: 230/240 Vac, 6 A general use, C300 pilot duty
 - NC contacts: 230/240 Vac, 6 A resistive, B300 pilot duty
 Notes:
 - Use 60 or 75°C copper (Cu) conductor and wire size No. 30-12 AWG, stranded or solid.
 - The terminal tightening torque of 5-7 lb in.
 - Only for 10 ... 30 Vdc and 24 Vac/dc versions: supply from remote Class 2 source or limited voltage limited energy.
 - Utiliser des conducteurs en cuivre (Cu) 60 ou 75°C rigides ou flexibles de section 30-12 AWG.
 - Couple de serrage des bornes de 5-7 Lb In.
 - Seulement pour les versions 10 ... 30 Vdc et 24 Vac/dc, alimenter avec sources de classes 2 ou avec tension limitée et énergie limitée.



Safety module CS AR-02

Pin assignment

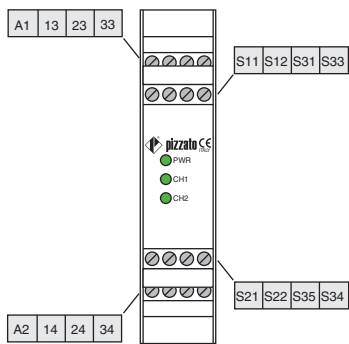

Internal wiring diagram

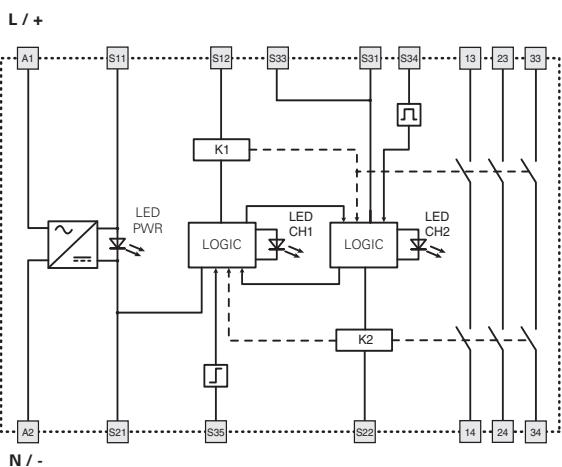

Function diagrams

Configuration with automatic start

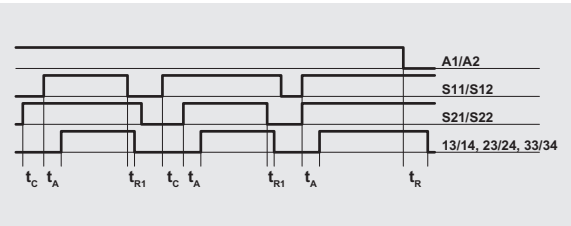

Configuration with monitored start

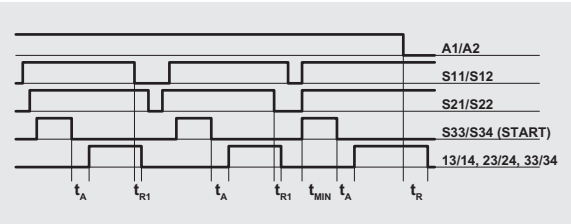

Configuration with manual start

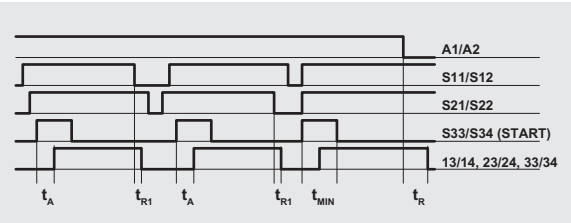

- Legend:
- t_{MIN} : Min. duration of start impulse
 - t_c : Simultaneity time
 - t_A : Response time
 - t_{R1} : Release time
 - t_R : Release time in absence of power supply

Notes:
The configurations with one channel are obtained taking into consideration the S11/S12 input only. In this case it is necessary to consider time t_{R1} referred to input S11/S12, time t_R referred to the supply, time t_A referred to input S11/S12 and to the start, and time t_{MIN} referred to the start.

Input configuration

OSSD semiconductor outputs (e.g. ST, NS, NG series or light barriers)
Input configuration with manual start
1 channel 2 channels

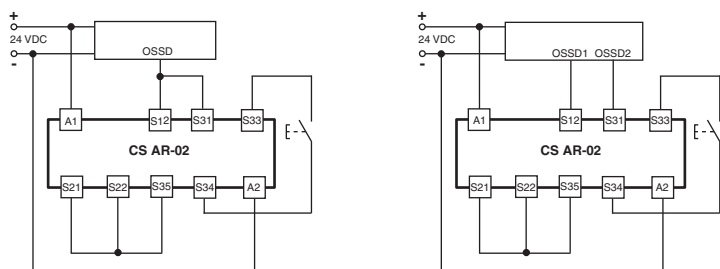

Emergency stop circuits
Input configuration with manual start
1 channel 2 channels

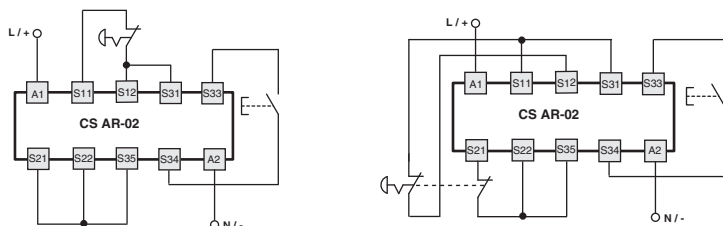

The diagram does not show the exact position of the terminals in the product

Automatic start

With regard to the indicated diagrams, bridge the start button between S33 and S34 in order to activate the automatic start module.

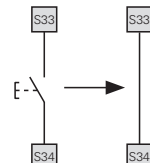

Monitored start

With regard to the indicated diagrams, remove the connection between the S22 and S35 terminals in order to activate the monitored start module.

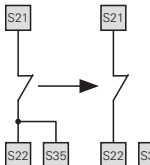

Monitoring of movable guards and magnetic safety sensors

The safety module can monitor emergency stop circuits, control circuits for movable guards as well as magnetic safety sensors. Replace the emergency stop contacts with switch contacts or sensor contacts. The sensors can only be used in 2-channel configuration.

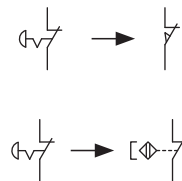

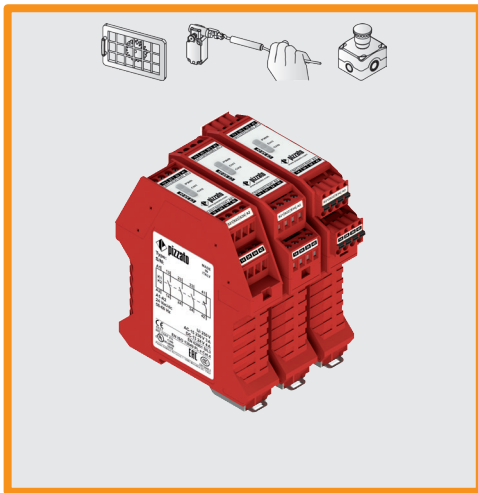

Module for emergency stops, end position monitoring for movable guards and magnetic safety sensors

Main features

- For safety applications up to SIL 3/PL e
- Inputs: 1 or 2 channels, which can be connected to electromechanical contacts or magnetic safety sensors
- Connection of input channels of opposite potentials
- Outputs: relay, 3NO safety, 1NC signalling
- Input with configurable start: automatic, manual or monitored
- Supply voltage: 24 Vac/dc, 120 Vac, 230 Vac

Quality marks:



EC type examination certificate: IMQ CP 432 DM
 UL approval: E131787
 CCC approval: 2024010305656748
 EAC approval: RU Д-IT.PA07.B.37848/24

Compliance with the requirements of:

Machinery Directive 2006/42/EC,
 EMC Directive 2014/30/EU,
 RoHS Directive 2011/65/EU.

In compliance with standards:

EN 60204-1, EN ISO 13855, EN ISO 14118,
 EN ISO 12100, EN ISO 13850, EN 60529, EN 61000-6-2,
 EN 61000-6-3, EN 61326-1, EN 60664-1, EN 60947-1,
 EN IEC 63000, EN ISO 13849-1, EN ISO 13849-2,
 EN 62061, UL 508, CSA C22.2 No. 14, GB/T14048.5

Technical data

Housing

Polyamide housing PA 66, self-extinguishing V0 acc. to UL 94
 Protection degree acc. to EN 60529: IP40 (housing), IP20 (terminal strip)
 Dimensions: see page 135, design A

General data

Safety Integrity Level (SIL) up to: Maximum SIL 3 acc. to EN 62061
 Performance Level (PL) up to: PL e acc. to EN ISO 13849-1
 Safety category up to: cat. 4 acc. to EN ISO 13849-1
 Safety parameters: See page 151
 Ambient temperature: -25°C...+55°C
 Mechanical endurance: >10 million operating cycles
 Electrical endurance: >100,000 operating cycles
 Pollution degree: external 3, internal 2
 Rated impulse withstand voltage (U_{imp}): 4 kV
 Rated insulation voltage (U_i): 250 V
 Overvoltage category: II

Power supply

Rated supply voltage (U_n): 24 Vac/dc; 50...60 Hz
 120 Vac; 50...60 Hz
 230 Vac; 50...60 Hz
 Max. DC residual ripple in DC: 10%
 Supply voltage tolerance: $\pm 15\%$ of U_n
 Power consumption AC: < 5 VA
 Power consumption DC: < 2 W

Control circuit

Protection against short circuits: PTC resistance, $I_h=0.5$ A
 PTC times: response > 100 ms, reset > 3 s
 Maximum resistance per input: $\leq 50 \Omega$
 Current per input: < 30 mA
 Min. duration of start impulse t_{MIN} : > 100 ms
 Response time t_A : < 50 ms
 Release time t_{R1} : < 20 ms
 Release time in absence of power supply t_R : < 70 ms
 Simultaneity time t_C : unlimited

Output circuit

Output contacts: 3 NO safety contacts
 1 NC auxiliary contact
 forcibly guided
 silver alloy
 Maximum switching voltage: 230/240 Vac; 300 Vdc
 Utilization categories for output contacts: AC-15 (50 ... 60 Hz), 230 V / 3 A
 DC-13 (6 oper. cycles/min.), 24 V / 4 A
 Maximum conventional free air thermal current per branch I_{th} : 6 A
 Max. total current ΣI_{th}^2 : 64 A²
 Minimum current: 10 mA
 Contact resistance: ≤ 100 m Ω
 External protection fuse: 4 A

The number and the load capacity of output contacts can be increased by using expansion modules or contactors. See pages 75-84.

Code structure

CS AR-04V024

Connection type		Supply voltage	
V	Screw terminals	024	24 Vac/dc
M	Connector with screw terminals	120	120 Vac
X	Connector with spring terminals	230	230 Vac

Features approved by UL

Rated supply voltage (U_n): 24 Vac/dc; 50...60 Hz
 120 Vac; 50...60 Hz
 230 Vac; 50...60 Hz
 Power consumption AC: < 5 VA
 Power consumption DC: < 4 W
 Electrical ratings:
 - NO contacts: 230/240 Vac, 6 A general use, C300 pilot duty
 - NC contacts: 230/240 Vac, 6 A resistive, B300 pilot duty
 Notes:
 - Use 60 or 75°C copper (Cu) conductor and wire size No. 30-12 AWG, stranded or solid.
 - The terminal tightening torque of 5-7 lb in.
 - Only for 24 Vac/dc versions: supply from remote Class 2 source or limited voltage limited energy.
 - Utiliser des conducteurs en cuivre (Cu) 60 ou 75°C rigides ou flexibles de section 30-12 AWG.
 - Couple de serrage des bornes de 5-7 Lb In.
 - Seulement pour les versions 24 Vac/dc, alimenter avec sources de classes 2 ou avec tension limitée et énergie limitée.



Safety module CS AR-04

Pin assignment

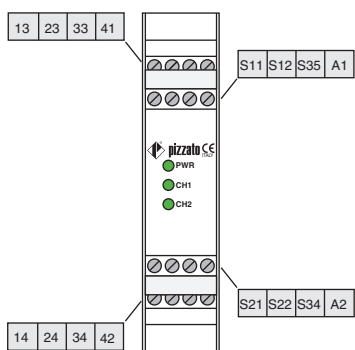

Internal wiring diagram

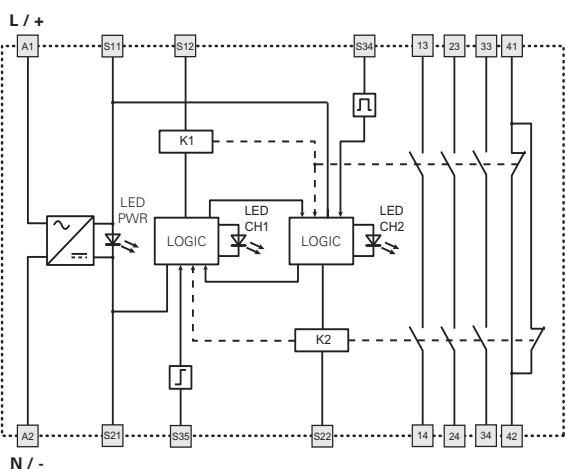

Input configuration

Emergency stop circuits	
Input configuration with manual start	
1 channel	2 channels

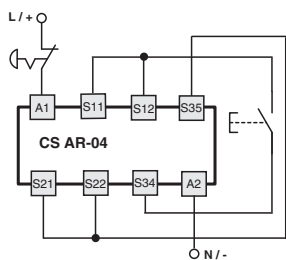

The diagram does not show the exact position of the terminals in the product

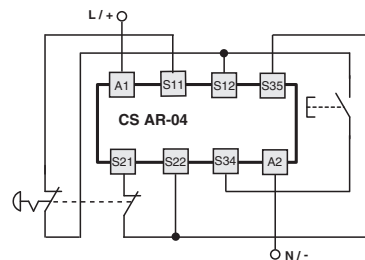

Automatic start

With regard to the indicated diagrams, bridge the start button between S12 and S34 in order to activate the automatic start module.

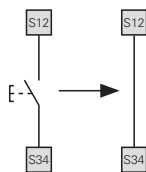

Monitored start

With regard to the indicated diagrams, remove the connection between the S22 and S35 terminals in order to activate the monitored start module.

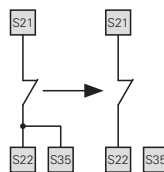

Monitoring of movable guards and magnetic safety sensors

The safety module can monitor emergency stop circuits, control circuits for movable guards as well as magnetic safety sensors. Replace the emergency stop contacts with switch contacts or sensor contacts.

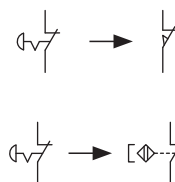

The sensors can only be used in 2-channel configuration.

Function diagrams

Configuration with automatic start

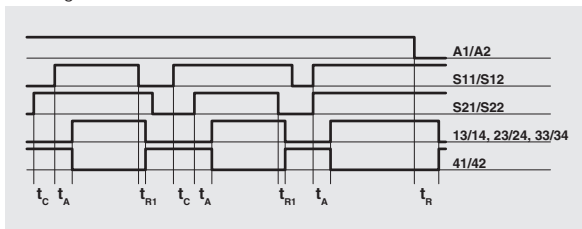

Configuration with monitored start

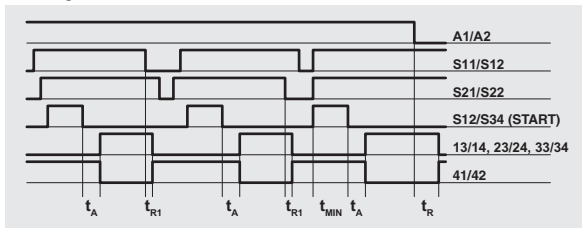

Configuration with manual start

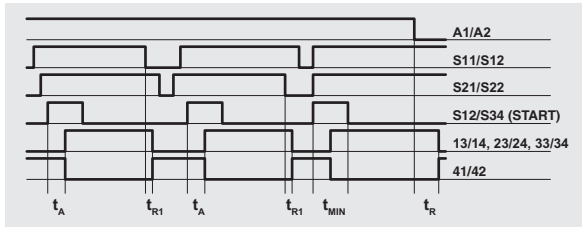

Legend:

- t_{MIN} : Min. duration of start impulse
- t_C : Simultaneity time
- t_A : Response time
- t_{R1} : Release time
- t_R : Release time in absence of power supply

Notes:

The configurations with one channel are obtained taking into consideration only the effect of the S11/S12 input on the supply. In this case it is necessary to consider time t_{R1} referred to input S11/S12, time t_R referred to the supply, time t_A referred to input S11/S12 and to the start, and time t_{MIN} .

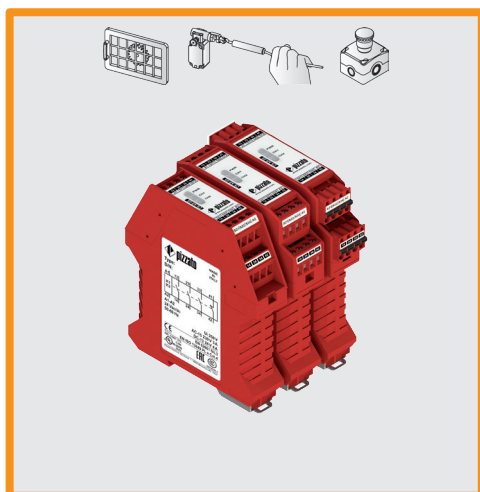

Module for emergency stops, end position monitoring for movable guards, OSSD semiconductor outputs and magnetic safety sensors

Main features

- For safety applications up to SIL 3/PL e
- Inputs: 1 or 2 channels, which can be connected to electromechanical contacts, magnetic safety sensors or OSSD solid-state outputs
- Outputs: relay, 3NO safety, 1NC signalling
- Input with configurable start: automatic, manual (CS AR-05 only) or monitored (CS AR-06 only)
- Supply voltage: 24 Vac/dc, 120 Vac, 230 Vac

Quality marks:



EC type examination certificate: IMQ CP 432 DM

UL approval: E131787

CCC approval: 2024010305656748

EAC approval: RU Д-IT.PA07.B.37848/24

Compliance with the requirements of:

Machinery Directive 2006/42/EC,

EMC Directive 2014/30/EU,

RoHS Directive 2011/65/EU.

In compliance with standards:

EN 60204-1, EN ISO 13855, EN ISO 14118,
EN ISO 12100, EN ISO 13850, EN 60529, EN 61000-6-2,
EN 61000-6-3, EN 61326-1, EN 60664-1, EN 60947-1,
EN IEC 63000, EN ISO 13849-1, EN ISO 13849-2,
EN 62061, UL 508, CSA C22.2 No. 14, GB/T14048.5

Technical data

Housing

Polyamide housing PA 66, self-extinguishing V0 acc. to UL 94

Protection degree acc. to EN 60529: IP40 (housing), IP20 (terminal strip)

Dimensions: see page 135, design A

General data

Safety Integrity Level (SIL) up to: Maximum SIL 3 acc. to EN 62061

Performance Level (PL) up to: PL e acc. to EN ISO 13849-1

Safety category up to: cat. 4 acc. to EN ISO 13849-1

Safety parameters: See page 151

Ambient temperature: -25°C...+55°C

Mechanical endurance: >10 million operating cycles

Electrical endurance: >100,000 operating cycles

Pollution degree: external 3, internal 2

Rated impulse withstand voltage (U_{imp}): 4 kV

Rated insulation voltage (U_i): 250 V

Overtoltage category: II

Power supply

Rated supply voltage (U_n):

24 Vac/dc; 50...60 Hz

120 Vac/dc; 50...60 Hz

230 Vac/dc; 50...60 Hz

Max. DC residual ripple in DC: 10%

Supply voltage tolerance:

-10% ... +15% of U_n for 24 Vac/dc

±15% of U_n for 120 Vac, 230 Vac

Power consumption AC: < 5 VA

Power consumption DC: < 2 W

Control circuit

Protection against short circuits: PTC resistance, $I_h=0.5$ A

PTC times: response > 100 ms, reset > 3 s

Maximum resistance per input: ≤ 50 Ω

Current per input: < 30 mA

Min. duration of start impulse t_{MIN} : > 250 ms

Response time t_A : < 300 ms

Release time t_{R1} : < 15 ms

Release time in absence of power supply t_{R2} : < 70 ms

Simultaneity time t_C : unlimited

Output circuit

Output contacts:

3 NO safety contacts

1 NC auxiliary contact

forcibly guided

Contact type: silver alloy

Material of the contacts: 230/240 Vac; 300 Vdc

Maximum switching voltage: AC-15 (50...60 Hz), 230 V / 3 A

Utilization categories for output contacts: DC-13 (6 oper. cycles/min.), 24 V / 4 A

Maximum conventional free air thermal current per branch I_{th} : 6 A

Max. total current ΣI_{th}^2 : 64 A²

Minimum current: 10 mA

Contact resistance: ≤ 100 mΩ

External protection fuse: 4 A

The number and the load capacity of output contacts can be increased by using expansion modules or contactors. See pages 75-84.

Code structure

CS AR-05V024

Start mode

05 manual or automatic start

06 monitored start

Connection type

V Screw terminals

M Connector with screw terminals

X Connector with spring terminals

Supply voltage

024 24 Vac/dc

120 120 Vac

230 230 Vac

Features approved by UL

Rated supply voltage (U_n): 24 Vac/dc; 50...60 Hz

120 Vac; 50...60 Hz

230 Vac; 50...60 Hz

Power consumption AC: < 5 VA

Power consumption DC: < 4 W

Electrical ratings:

- NO contacts: 230/240 Vac, 6 A general use, C300 pilot duty

- NC contacts: 230/240 Vac, 6 A resistive, B300 pilot duty

Notes:

- Use 60 or 75°C copper (Cu) conductor and wire size No. 30-12 AWG, stranded or solid.

- The terminal tightening torque of 5-7 lb in.

- Only for 24 Vac/dc versions: supply from remote Class 2 source or limited voltage limited energy.

- Utiliser des conducteurs en cuivre (Cu) 60 ou 75°C rigides ou flexibles de section 30-12 AWG.

- Couple de serrage des bornes de 5-7 Lb In.

- Seulement pour les versions 24 Vac/dc, alimenter avec sources de classes 2 ou avec tension limitée et énergie limitée.

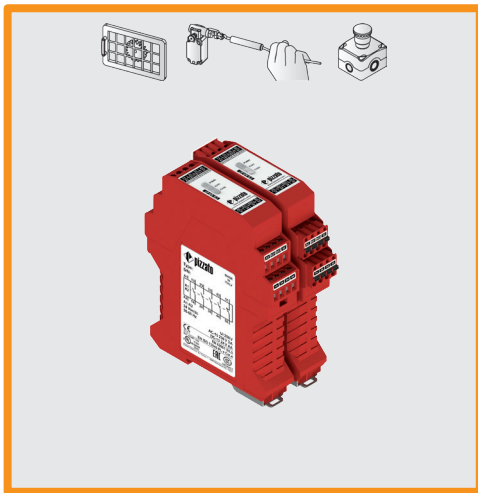

Module for emergency stops and end position monitoring for movable guards

Main features

- For safety applications up to SIL 3/PL e
- Inputs: 1 or 2 channels, which can be connected to electromechanical contacts
- Connection of input channels of opposite potentials
- Outputs: relay, 4NO safety, 1NC signalling
- Input with configurable start: automatic, manual or monitored
- Supply voltage: 24 Vac/dc

Quality marks:



EC type examination certificate: IMQ CP 432 DM
 UL approval: E131787
 CCC approval: 2024010305656748
 EAC approval: RU Д-IT.PA07.B.37848/24

Compliance with the requirements of:

Machinery Directive 2006/42/EC,
 EMC Directive 2014/30/EU,
 RoHS Directive 2011/65/EU.

In compliance with standards:

EN 60204-1, EN ISO 13855, EN ISO 14118,
 EN ISO 12100, EN ISO 13850, EN 60529, EN 61000-6-2,
 EN 61000-6-3, EN 61326-1, EN 60664-1, EN 60947-1,
 EN IEC 63000, EN ISO 13849-1, EN ISO 13849-2,
 EN 62061, UL 508, CSA C22.2 No. 14, GB/T14048.5

Technical data

Housing

Polyamide housing PA 66, self-extinguishing V0 acc. to UL 94
 Protection degree acc. to EN 60529: IP40 (housing), IP20 (terminal strip)
 Dimensions: see page 135, design B

General data

Safety Integrity Level (SIL) up to: Maximum SIL 3 acc. to EN 62061
 Performance Level (PL) up to: PL e acc. to EN ISO 13849-1
 Safety category up to: cat. 4 acc. to EN ISO 13849-1
 Safety parameters: See page 151
 Ambient temperature: -25°C...+55°C
 Mechanical endurance: >10 million operating cycles
 Electrical endurance: >100,000 operating cycles
 Pollution degree: external 3, internal 2
 Rated impulse withstand voltage (U_{imp}): 4 kV
 Rated insulation voltage (U): 250 V
 Overvoltage category: II

Power supply

Rated supply voltage (U_n): 24 Vac/dc; 50...60 Hz
 Max. DC residual ripple in DC: 10%
 Supply voltage tolerance: $\pm 15\%$ of U_n
 Power consumption AC: < 5 VA
 Power consumption DC: < 2 W

Control circuit

Protection against short circuits: PTC resistance, $I_h=0.5 A$
 PTC times: response > 100 ms, reset > 3 s
 Maximum resistance per input: $\leq 50 \Omega$
 Current per input: < 30 mA
 Min. duration of start impulse t_{MIN} : > 100 ms
 Response time t_A : < 70 ms
 Release time t_{R1} : < 40 ms
 Release time in absence of power supply t_{R2} : < 80 ms
 Simultaneity time t_C : unlimited

Output circuit

Output contacts: 4 NO safety contacts
 1 NC auxiliary contact
 forcibly guided
 Contact type: silver alloy
 Material of the contacts: 230/240 Vac; 220 Vdc
 Maximum switching voltage: AC-15 (50 ... 60 Hz), 230 V / 3 A
 Utilization categories for output contacts: DC-13 (6 oper. cycles/min.), 24 V / 4 A
 Maximum conventional free air thermal current per branch I_{th} : 6 A
 Max. total current ΣI_{th}^2 : 72 A²
 Minimum current: 10 mA
 Contact resistance: $\leq 100 m\Omega$
 External protection fuse: 4 A

The number and the load capacity of output contacts can be increased by using expansion modules or contactors. See pages 75-84.

Code structure

CS AR-07M024

Connection type	
M	Connector with screw terminals
X	Connector with spring terminals

Supply voltage	
024	24 Vac/dc

Features approved by UL

Rated supply voltage (U_n): 24 Vac/dc; 50...60 Hz
 Power consumption AC: < 5 VA
 Power consumption DC: < 4 W
 Electrical ratings:
 - NO contacts: 230/240 Vac, 6 A general use, C300 pilot duty
 - NC contacts: 230/240 Vac, 6 A resistive, B300 pilot duty

Notes:
 - Use 60 or 75°C copper (Cu) conductor and wire size No. 30-12 AWG, stranded or solid.
 - The terminal tightening torque of 5-7 lb in.
 - Only for 24 Vac/dc versions: supply from remote Class 2 source or limited voltage limited energy.
 - Utiliser des conducteurs en cuivre (Cu) 60 ou 75°C rigides ou flexibles de section 30-12 AWG.
 - Couple de serrage des bornes de 5-7 lb In.
 - Seulement pour les versions 24 Vac/dc, alimenter avec sources de classes 2 ou avec tension limitée et énergie limitée.



Safety module CS AR-07

Pin assignment

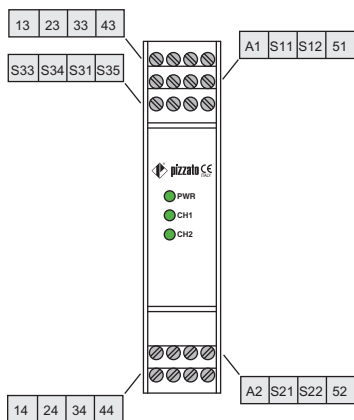

Internal wiring diagram

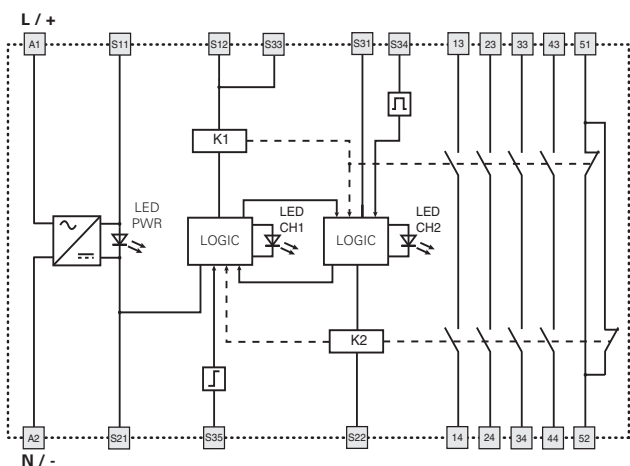

Input configuration

Emergency stop circuits	
Input configuration with manual start	
1 channel	2 channels

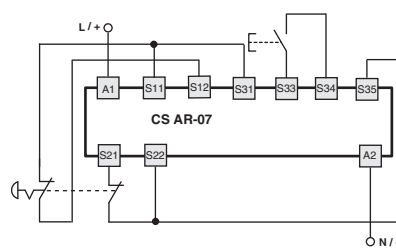
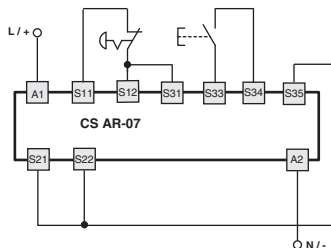

The diagram does not show the exact position of the terminals in the product

Automatic start

With regard to the indicated diagrams, bridge the start button between S33 and S34 in order to activate the automatic start module.

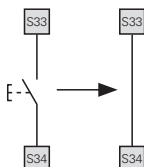

Monitored start

With regard to the indicated diagrams, remove the connection between the S22 and S35 terminals in order to activate the monitored start module.

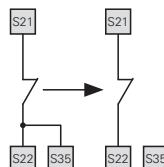

Movable guard monitoring

The safety module can monitor emergency stop circuits and control circuits for movable guards. Replace the emergency stop contacts with the switch contacts.

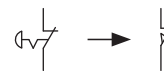

Function diagrams

Configuration with automatic start

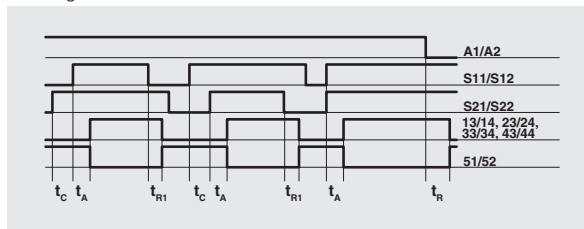

Configuration with monitored start

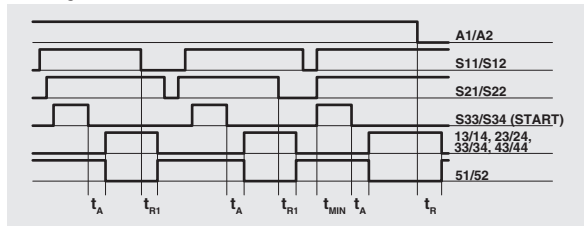

Configuration with manual start

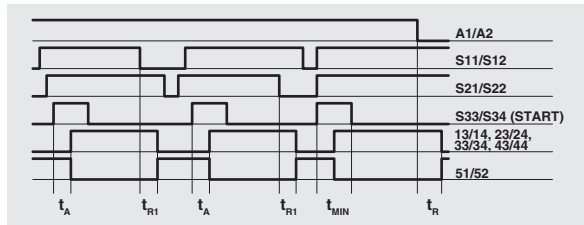

Legend:

- t_{MIN} : Min. duration of start impulse
- t_C : Simultaneity time
- t_A : Response time
- t_{R1} : Release time
- t_R : Release time in absence of power supply

Notes:

The configurations with one channel are obtained taking into consideration the S11/S12 input only. In this case it is necessary to consider time t_{R1} referred to input S11/S12, time t_R referred to the supply, time t_A referred to input S11/S12 and to the start, and time t_{MIN} referred to the start.

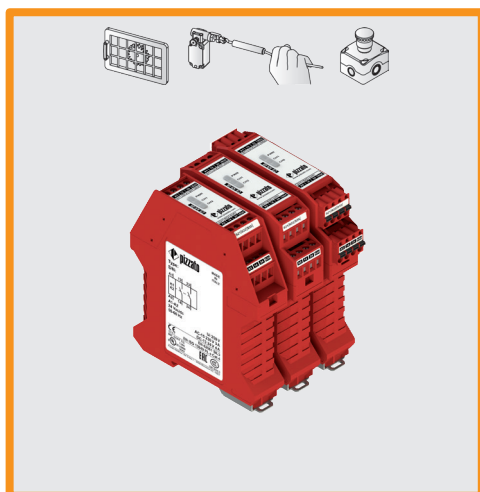

Module for emergency stops, end position monitoring for movable guards, OSSD semiconductor outputs and magnetic safety sensors

Main features

- For safety applications up to SIL 3/PL e
- Inputs: 1 or 2 channels, which can be connected to electromechanical contacts, magnetic safety sensors or OSSD solid-state outputs
- Outputs: relay, 2NO safety
- Input with configurable start: automatic, manual or monitored
- Supply voltage: 12 Vdc, 24 Vac/dc, 120 Vac, 230 Vac
- Possibility of parallel reset of several modules

Quality marks:



EC type examination certificate: IMQ CP 432 DM

UL approval: E131787

CCC approval: 2024010305656748

TÜV SÜD approval: Z10 18 05 75157 018

EAC approval: RU Д-IT.PA07.B.37848/24

Compliance with the requirements of:

Machinery Directive 2006/42/EC,

EMC Directive 2014/30/EU,

RoHS Directive 2011/65/EU.

In compliance with standards:

EN 60204-1, EN ISO 13855, EN ISO 14118,
EN ISO 12100, EN ISO 13850, EN 60529, EN 61000-6-2,
EN 61000-6-3, EN 61326-1, EN 60664-1, EN 60947-1,
EN 60947-5-3, EN 61508-1, EN 61508-2, EN 61508-4,
EN IEC 63000, EN ISO 13849-1, EN ISO 13849-2,
EN 62061, UL 508, CSA C22.2 No. 14, GB/T14048.5

Code structure

CS AR-08V024

Connection type		Supply voltage	
V	Screw terminals	U12	12 Vdc
M	Connector with screw terminals	024	24 Vac/dc
X	Connector with spring terminals	120	120 Vac
		230	230 Vac

Technical data

Housing

Polyamide housing PA 66, self-extinguishing V0 acc. to UL 94

Protection degree acc. to EN 60529:

IP40 (housing), IP20 (terminal strip)

Dimensions:

see page 135, design A

General data

Safety Integrity Level (SIL) up to:

Maximum SIL 3 acc. to EN 62061

Performance Level (PL) up to:

PL e acc. to EN ISO 13849-1

Safety category up to:

cat. 4 acc. to EN ISO 13849-1

Safety parameters:

See page 151

Ambient temperature:

-25°C...+55°C

Mechanical endurance:

>10 million operating cycles

Electrical endurance:

>100,000 operating cycles

Pollution degree:

external 3, internal 2

Rated impulse withstand voltage (U_{imp}):

4 kV

Rated insulation voltage (U_i):

250 V

Overvoltage category:

II

Power supply

Rated supply voltage (U_n):

12 Vdc
24 Vac/dc; 50...60 Hz
120 Vac; 50...60 Hz
230 Vac; 50...60 Hz

Max. DC residual ripple in DC:

10%

Supply voltage tolerance:

$\pm 15\%$ of U_n for 24 Vac/dc, 120 Vac, 230 Vac
 -10% ... $+15\%$ of U_n for 12 Vdc

Power consumption AC:

< 5 VA

Power consumption DC:

< 2 W

Control circuit

Protection against short circuits:

PTC resistance, $I_h=0.5$ A

PTC times:

response > 100 ms, reset > 3 s

Maximum resistance per input:

$\leq 50 \Omega$ (15 Ω)*

Current per input:

< 40 mA (< 70 mA)*

Min. duration of start impulse t_{MIN} :

> 100 ms

Response time t_A :

< 300 ms (220 ms)*

Release time t_{R1} :

< 20 ms (15 ms)*

Release time in absence of power supply t_{R2} :

< 200 ms (50 ms)*

Simultaneity time t_C :

unlimited

* Version CS AR-08•U12

Output circuit

Output contacts:

2 NO safety contacts,

Contact type:

forcibly guided

Material of the contacts:

silver alloy

Maximum switching voltage:

230/240 Vac; 300 Vdc

Utilization categories for output contacts:

AC-15 (50 ... 60 Hz), 230 V / 3 A

DC-13 (6 oper. cycles/min.), 24 V / 4 A

Maximum conventional free air thermal current per branch I_{th} :

6 A

Max. total current ΣI_{th}^2 :

36 A²

Minimum current:

10 mA

Contact resistance:

≤ 100 m Ω

External protection fuse:

4 A

The number and the load capacity of output contacts can be increased by using expansion modules or contactors. See pages 75-84.

Features approved by UL

Rated supply voltage (U_n): 12 Vdc, 24 Vac/dc; 50...60 Hz,
120 Vac; 50...60 Hz, 230 Vac; 50...60 Hz

Power consumption AC: < 5 VA

Power consumption DC: < 4 W

Electrical ratings:

- NO contacts: 230/240 Vac, 6 A general use, C300 pilot duty

- NC contacts: 230/240 Vac, 6 A resistive, B300 pilot duty

Notes:

- Use 60 or 75°C copper (Cu) conductor and wire size No. 30-12 AWG, stranded or solid.

- The terminal tightening torque of 5-7 lb in.

- Only for 12 Vdc and 24 Vac/dc versions: supply from remote Class 2 source or limited voltage limited energy.

- Utiliser des conducteurs en cuivre (Cu) 60 ou 75°C rigides ou flexibles de section 30-12 AWG.

- Couple de serrage des bornes de 5-7 Lb In.

- Seulement pour les versions 12 Vdc et 24 Vac/dc, alimenter avec sources de classes 2 ou avec tension limitée et énergie limitée.

Features approved by TÜV SÜD

Rated supply voltage (U_i): 24 Vac/dc $\pm 15\%$,
120 Vac $\pm 15\%$, 230 Vac $\pm 15\%$

Power consumption: 5 VA max AC, 2 W max DC

Rated operating current (max.): 4 A

Maximum switching load (max.): 1380 VA

Ambient temperature: -25°C ... +55°C

Storage temperature: -25 °C ... +70°C

Protection degree: IP40 (housing), IP20 (terminal strip)

In compliance with standards: 2006/42/EC Machinery Directive,
EN ISO 13849-1:2015 (up to Cat. 4 PL e), EN 60947-5-3:2013, EN 61508-1:2010
(up to SIL 3), EN 61508-2:2010 (up to SIL 3), EN 61508-4:2010 (up to SIL 3),
EN 62061:2005/A2:2015 (up to SIL CL 3)



Safety module CS AR-08

Pin assignment

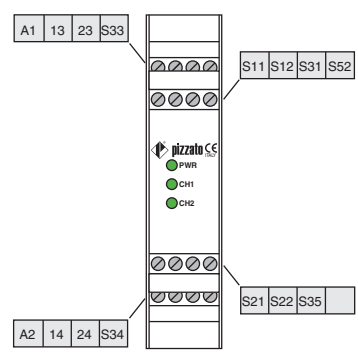

Function diagrams

Configuration with automatic start

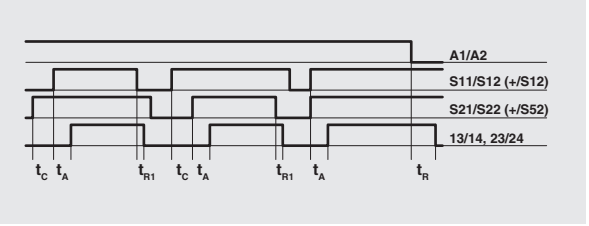

Configuration with monitored start

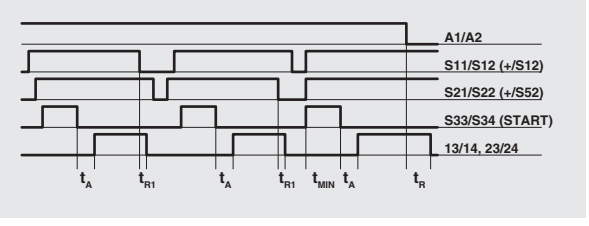

Configuration with manual start

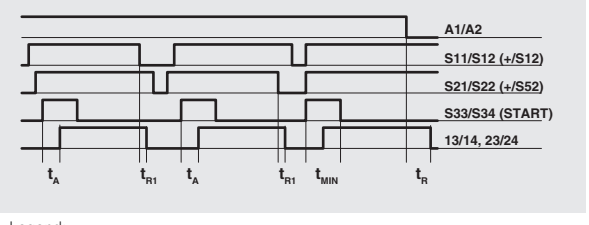

Legend:
 t_{MIN} : Min. duration of start impulse
 t_{c} : Simultaneity time
 t_{A} : Response time
 t_{R1} : Release time
 t_{R} : Release time in absence of power supply

Notes:
 The configurations with one channel are obtained taking into consideration the CH1 input only. In this case it is necessary to consider time t_{R1} referred to input CH1, time t_A referred to the supply, time t_A referred to input CH1 and to the start, and time t_{MIN} referred to the start.

Internal wiring diagram

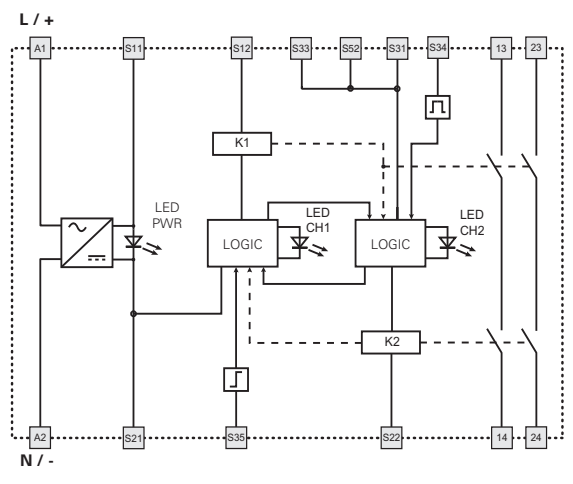

Input configuration

OSSD semiconductor outputs (e.g. ST, NS, NG series or light barriers)

Input configuration with manual start

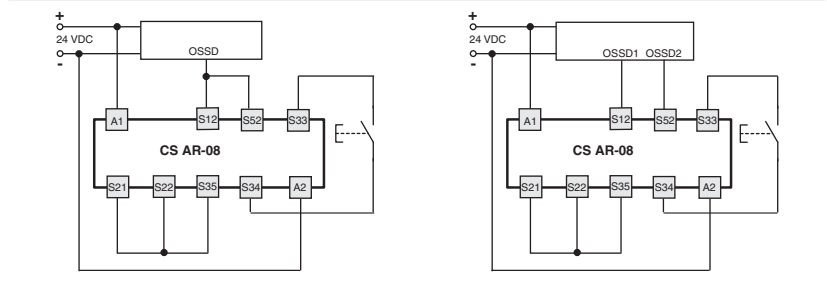

Automatic start

With regard to the indicated diagrams, bridge the start button between S33 and S34 in order to activate the automatic start module.

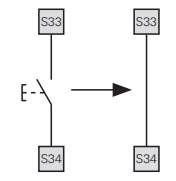

Monitored start

With regard to the indicated diagrams, remove the connection between the S22 and S35 terminals in order to activate the monitored start module.

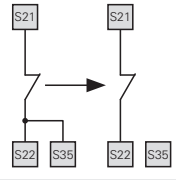

Emergency stop circuits

Input configuration with manual start

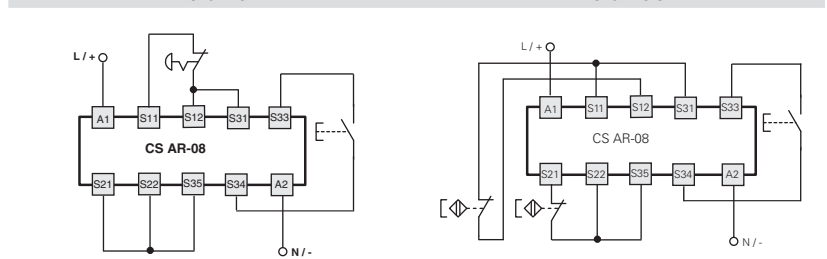

Monitoring of movable guards and magnetic safety sensors

The safety module can monitor emergency stop circuits, control circuits for movable guards as well as magnetic safety sensors. Replace the emergency stop contacts with switch contacts or sensor contacts. The sensors can only be used in 2-channel configuration.

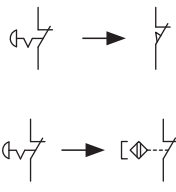

The diagram does not show the exact position of the terminals in the product

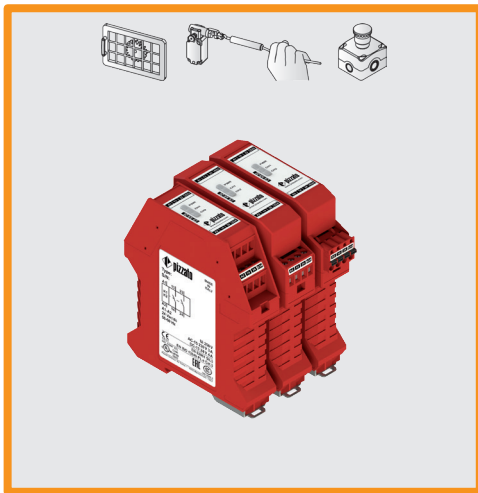

Module for emergency stops and end position monitoring for movable guards

Main features

- For safety applications up to SIL 3/PL e
- Inputs: 1 or 2 channels, which can be connected to electromechanical contacts
- Outputs: relay, 2NO safety
- Input with configurable start: automatic, manual (CS AR-20 only) or monitored (CS AR-21 only)
- Supply voltage: 24 Vac/dc, 120 Vac, 230 Vac

Quality marks:



EC type examination certificate: IMQ CP 432 DM
 UL approval: E131787
 CCC approval: 2024010305656748
 EAC approval: RU Д-IT.PA07.B.37848/24

Compliance with the requirements of:

Machinery Directive 2006/42/EC,
 EMC Directive 2014/30/EU,
 RoHS Directive 2011/65/EU.

In compliance with standards:

EN 60204-1, EN ISO 13855, EN ISO 14118,
 EN ISO 12100, EN ISO 13850, EN 60529, EN 61000-6-2,
 EN 61000-6-3, EN 61326-1, EN 60664-1, EN 60947-1,
 EN IEC 63000, EN ISO 13849-1, EN ISO 13849-2,
 EN 62061, UL 508, CSA C22.2 No. 14, GB/T14048.5

Technical data

Housing

Polyamide housing PA 66, self-extinguishing V0 acc. to UL 94
 Protection degree acc. to EN 60529: IP40 (housing), IP20 (terminal strip)
 Dimensions: see page 135, design A

General data

Safety Integrity Level (SIL) up to: Maximum SIL 3 acc. to EN 62061
 Performance Level (PL) up to: PL e acc. to EN ISO 13849-1
 Safety category up to: cat. 3 acc. to EN ISO 13849-1
 Safety parameters: See page 151
 Ambient temperature: -25°C...+55°C
 Mechanical endurance: >10 million operating cycles
 Electrical endurance: >100,000 operating cycles
 Pollution degree: external 3, internal 2
 Rated impulse withstand voltage (U_{imp}): 4 kV
 Rated insulation voltage (U): 250 V
 Overvoltage category: II

Power supply

Rated supply voltage (U_n): 24 Vac/dc; 50...60 Hz
 120 Vac; 50...60 Hz
 230 Vac; 50...60 Hz
 Max. DC residual ripple in DC: 10%
 Supply voltage tolerance: $\pm 15\%$ of U_n
 Power consumption AC: < 5 VA
 Power consumption DC: < 2 W

Control circuit

Protection against short circuits: PTC resistance, $I_h=0.5$ A
 PTC times: response > 100 ms, reset > 3 s
 Maximum resistance per input: $\leq 50 \Omega$
 Current per input: < 70 mA
 Min. duration of start impulse t_{MIN} : > 100 ms
 Response time t_A : < 200 ms
 Release time in absence of power supply t_R : < 150 ms
 Simultaneity time t_C : unlimited

Output circuit

Output contacts: 2 NO safety contacts
 Contact type: forcibly guided
 Material of the contacts: silver alloy
 Maximum switching voltage: 230/240 Vac; 300 Vdc
 Utilization categories for output contacts: AC-15 (50 ... 60 Hz), 230 V / 3 A
 DC-13 (6 oper. cycles/min.), 24 V / 4 A
 Maximum conventional free air thermal current per branch I_{th} : 6 A
 Max. total current ΣI_{th}^2 : 36 A²
 Minimum current: 10 mA
 Contact resistance: ≤ 100 m Ω
 External protection fuse: 4 A

The number and the load capacity of output contacts can be increased by using expansion modules or contactors. See pages 75-84.

Code structure

CS AR-20V024

Start mode

20	manual or automatic start
21	monitored start

Supply voltage

024	24 Vac/dc
120	120 Vac
230	230 Vac

Connection type

V	Screw terminals
M	Connector with screw terminals
X	Connector with spring terminals

Features approved by UL

Rated supply voltage (U_n): 24 Vac/dc; 50...60 Hz
 120 Vac; 50...60 Hz
 230 Vac; 50...60 Hz
 Power consumption AC: < 5 VA
 Power consumption DC: < 4 W
 Electrical ratings:
 - NO contacts: 230/240 Vac, 6 A general use, C300 pilot duty
 - NC contacts: 230/240 Vac, 6 A resistive, B300 pilot duty
 Notes:
 - Use 60 or 75°C copper (Cu) conductor and wire size No. 30-12 AWG, stranded or solid.
 - The terminal tightening torque of 5-7 lb in.
 - Only for 24 Vac/dc versions: supply from remote Class 2 source or limited voltage limited energy.
 - Utiliser des conducteurs en cuivre (Cu) 60 ou 75°C rigides ou flexibles de section 30-12 AWG.
 - Couple de serrage des bornes de 5-7 Lb In.
 - Seulement pour les versions 24 Vac/dc, alimenter avec sources de classes 2 ou avec tension limitée et énergie limitée.



Safety module CS AR-20 / CS AR-21

Pin assignment

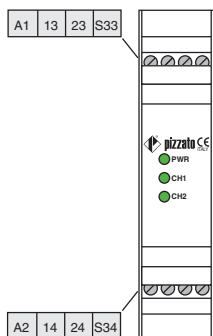

Internal wiring diagram

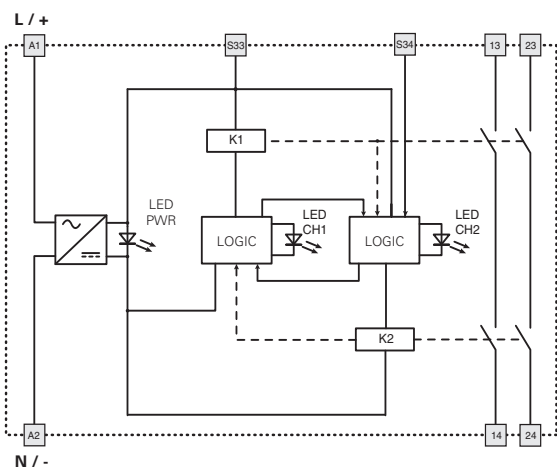

Function diagrams

Configuration with automatic start (CS AR-20 only)

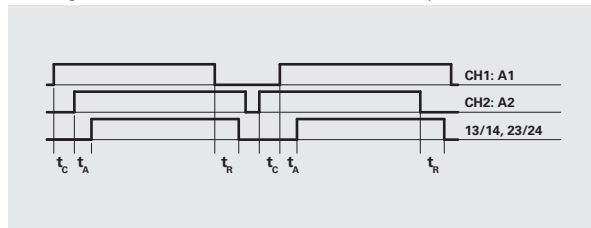

Configuration with monitored start (CS AR-21 only)

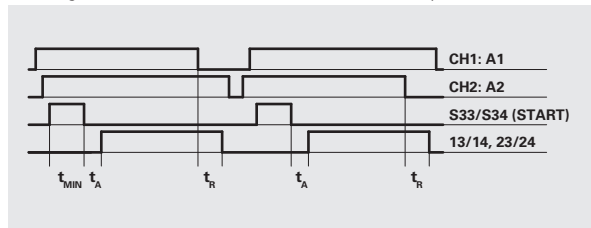

Configuration with manual start (CS AR-20 only)

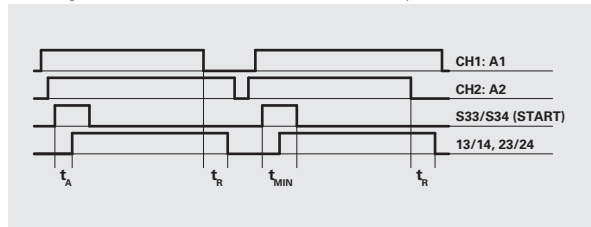

Legend:
 t_{MIN} : Min. duration of start impulse t_A : Response time
 t_c : Simultaneity time t_r : Release time in absence of power supply

Notes:
 The configurations with one channel are obtained taking into consideration the CH1:A1 input only. In this case it is necessary to consider time t_r referred to input CH1:A1, time t_A referred to input CH1:A1 and to the start, and time t_{MIN} referred to the start.

Input configuration

Emergency stop circuits	
Input configuration with manual start	
1 channel	2 channels

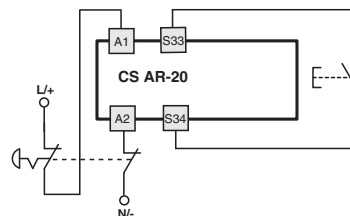
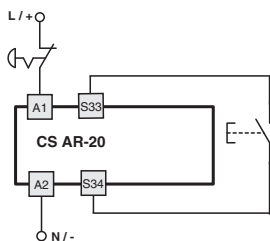

The diagram does not show the exact position of the terminals in the product

Automatic start

With regard to the indicated diagrams, bridge the start button between S33 and S34 in order to activate the automatic start module.

Monitored start

Use module CS AR-21 with the circuit diagrams for manual start.

Movable guard monitoring

The safety module can monitor emergency stop circuits and control circuits for movable guards. Replace the emergency stop contacts with the switch contacts.

Application examples See page 85

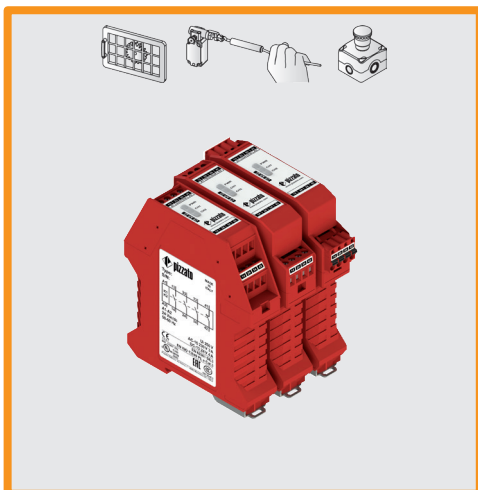

Module for emergency stops and end position monitoring for movable guards

Main features

- For safety applications up to SIL 3/PL e
- Inputs: 1 or 2 channels, which can be connected to electromechanical contacts
- Outputs: relay, 3NO safety, 1NC signalling
- Input with configurable start: automatic, manual (CS AR-22 only) or monitored (CS AR-23 only)
- Supply voltage: 24 Vac/dc, 120 Vac, 230 Vac

Quality marks:



EC type examination certificate: IMQ CP 432 DM

UL approval: E131787

CCC approval: 2024010305656748

EAC approval: RU Д-IT.PA07.B.37848/24

Compliance with the requirements of:

Machinery Directive 2006/42/EC,

EMC Directive 2014/30/EU,

RoHS Directive 2011/65/EU.

In compliance with standards:

EN 60204-1, EN ISO 13855, EN ISO 14118,
EN ISO 12100, EN ISO 13850, EN 60529, EN 61000-6-2,
EN 61000-6-3, EN 61326-1, EN 60664-1, EN 60947-1,
EN IEC 63000, EN ISO 13849-1, EN ISO 13849-2,
EN 62061, UL 508, CSA C22.2 No. 14, GB/T14048.5

Technical data

Housing

Polyamide housing PA 66, self-extinguishing V0 acc. to UL 94

Protection degree acc. to EN 60529:

IP40 (housing), IP20 (terminal strip)

Dimensions:

see page 135, design A

General data

Safety Integrity Level (SIL) up to:

Maximum SIL 3 acc. to EN 62061

Performance Level (PL) up to:

PL e acc. to EN ISO 13849-1

Safety category up to:

cat. 3 acc. to EN ISO 13849-1

Safety parameters:

See page 151

Ambient temperature:

-25°C...+55°C

Mechanical endurance:

>10 million operating cycles

Electrical endurance:

>100,000 operating cycles

Pollution degree:

external 3, internal 2

Rated impulse withstand voltage (U_{imp}):

4 kV

Rated insulation voltage (U):

250 V

Overvoltage category:

II

Power supply

Rated supply voltage (U_n):

24 Vac/dc; 50...60 Hz

120 Vac; 50...60 Hz

230 Vac; 50...60 Hz

Max. DC residual ripple in DC:

10%

Supply voltage tolerance:

±15% of U_n

Power consumption AC:

< 5 VA

Power consumption DC:

< 2 W

Control circuit

Protection against short circuits:

PTC resistance, $I_h=0.5$ A

PTC times:

response > 100 ms, reset > 3 s

Maximum resistance per input:

≤ 50 Ω

Current per input:

< 70 mA

Min. duration of start impulse t_{MIN} :

> 100 ms

Response time t_A :

< 50 ms

Release time in absence of power supply t_R :

< 75 ms

Simultaneity time t_C :

unlimited

Output circuit

Output contacts:

3 NO safety contacts

1 NC auxiliary contact

forcibly guided

silver alloy

Contact type:

Material of the contacts:

Maximum switching voltage:

Utilization categories for output contacts:

230/240 Vac; 300 Vdc

AC-15 (50 ... 60 Hz), 230 V / 3 A

DC-13 (6 oper. cycles/min.), 24 V / 4 A

Maximum conventional free air thermal current per branch I_{th} :

6 A

Max. total current ΣI_{th}^2 :

80 A²

Minimum current:

10 mA

Contact resistance:

≤ 100 mΩ

External protection fuse:

4 A

The number and the load capacity of output contacts can be increased by using expansion modules

or contactors. See pages 75-84.

Code structure

CS AR-22V024

Start mode

22 manual or automatic start

23 monitored start

Connection type

V Screw terminals

M Connector with screw terminals

X Connector with spring terminals

Supply voltage

024 24 Vac/dc

120 120 Vac

230 230 Vac

Features approved by UL

Rated supply voltage (U_n):

24 Vac/dc; 50...60 Hz

120 Vac; 50...60 Hz

230 Vac; 50...60 Hz

Power consumption AC:

< 5 VA

Power consumption DC:

< 4 W

Electrical ratings:

- NO contacts: 230/240 Vac, 6 A general use, C300 pilot duty

- NC contacts: 230/240 Vac, 6 A resistive, B300 pilot duty

Notes:

- Use 60 or 75°C copper (Cu) conductor and wire size No. 30-12 AWG, stranded or solid.

- The terminal tightening torque of 5-7 lb in.

- Only for 24 Vac/dc versions: supply from remote Class 2 source or limited voltage

limited energy.

- Utiliser des conducteurs en cuivre (Cu) 60 ou 75°C rigides ou flexibles de section

30-12 AWG.

- Couple de serrage des bornes de 5-7 Lb In.

- Seulement pour les versions 24 Vac/dc, alimenter avec sources de classes 2 ou

avec tension limitée et énergie limitée.



Safety module CS AR-22 / CS AR-23

Pin assignment

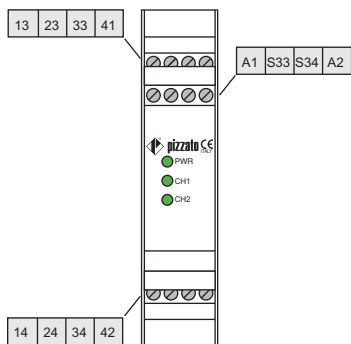

Internal wiring diagram

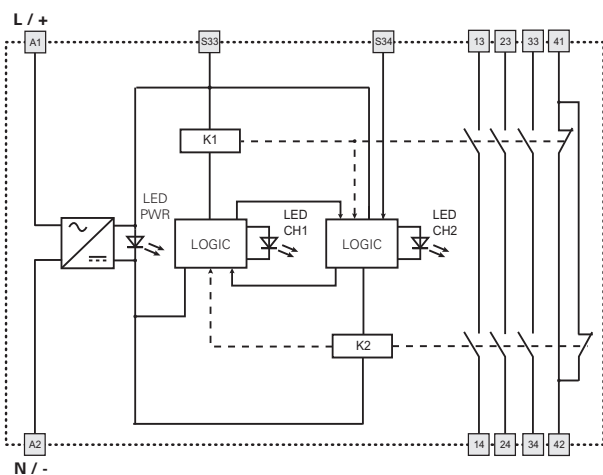

Input configuration

Emergency stop circuits	
Input configuration with manual start	
1 channel	2 channels

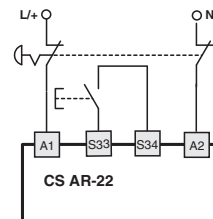
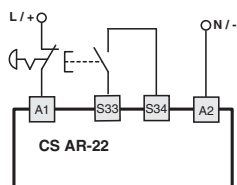

The diagram does not show the exact position of the terminals in the product

Automatic start

With regard to the indicated diagrams, bridge the start button between S33 and S34 in order to activate the automatic start module.

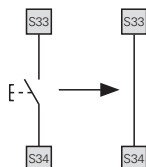

Monitored start

Use module CS AR-23 with the circuit diagrams for manual start.

Movable guard monitoring

The safety module can monitor emergency stop circuits and control circuits for movable guards. Replace the emergency stop contacts with the switch contacts.

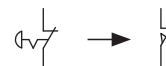

Function diagrams

Configuration with automatic start (CS AR-22 only)

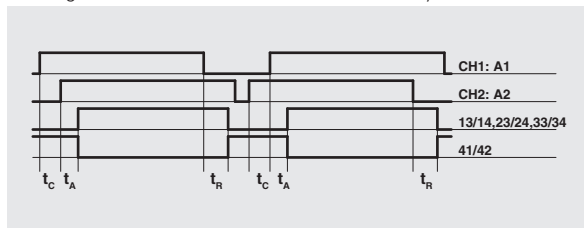

Configuration with monitored start (CS AR-23 only)

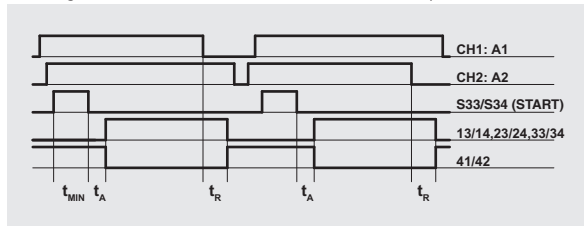

Configuration with manual start (CS AR-22 only)

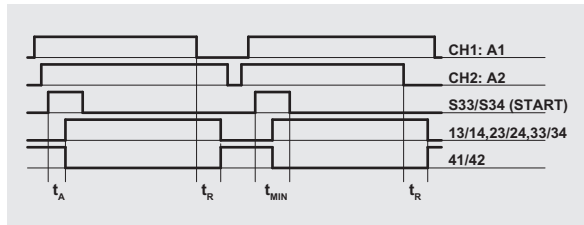

Legend:

t_{MIN} : Min. duration of start impulse t_A : Response time
 t_C : Simultaneity time t_R : Release time in absence of power supply

Notes:

The configurations with one channel are obtained taking into consideration the CH1:A1 input only. In this case it is necessary to consider time t_R referred to input CH1:A1, time t_A referred to input CH1:A1 and to the start, and time t_{MIN} referred to the start.

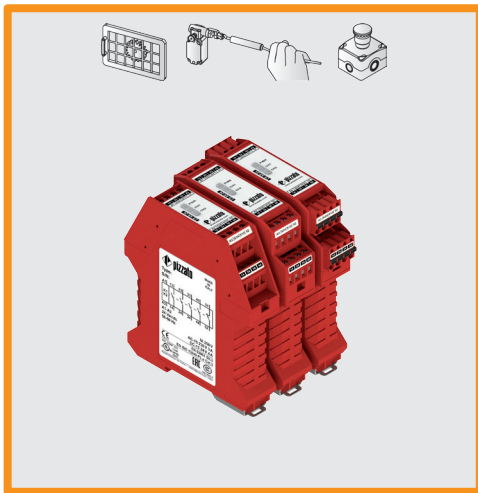

Module for emergency stops and end position monitoring for movable guards

Main features

- For safety applications up to SIL 3/PL e
- Inputs: 1 or 2 channels, which can be connected to electromechanical contacts
- Outputs: relay, 4NO safety, 1NC signalling
- Input with configurable start: automatic, manual (CS AR-24 only) or monitored (CS AR-25 only)
- Supply voltage: 24 Vac/dc

Quality marks:



EC type examination certificate: IMQ CP 432 DM

UL approval: E131787

CCC approval: 2024010305656748

EAC approval: RU Д-IT.PA07.B.37848/24

Compliance with the requirements of:

Machinery Directive 2006/42/EC,

EMC Directive 2014/30/EU,

RoHS Directive 2011/65/EU.

In compliance with standards:

EN 60204-1, EN ISO 13855, EN ISO 14118,
EN ISO 12100, EN ISO 13850, EN 60529, EN 61000-6-2,
EN 61000-6-3, EN 61326-1, EN 60664-1, EN 60947-1,
EN IEC 63000, EN ISO 13849-1, EN ISO 13849-2,
EN 62061, UL 508, CSA C22.2 No. 14, GB/T14048.5

Technical data

Housing

Polyamide housing PA 66, self-extinguishing V0 acc. to UL 94

Protection degree acc. to EN 60529:

IP40 (housing), IP20 (terminal strip)

Dimensions:

see page 135, design A

General data

Safety Integrity Level (SIL) up to:

Maximum SIL 3 acc. to EN 62061

Performance Level (PL) up to:

PL e acc. to EN ISO 13849-1

Safety category up to:

cat. 3 acc. to EN ISO 13849-1

Safety parameters:

See page 151

Ambient temperature:

-25°C...+55°C

Mechanical endurance:

>10 million operating cycles

Electrical endurance:

>100,000 operating cycles

Pollution degree:

external 3, internal 2

Rated impulse withstand voltage (U_{imp}):

4 kV

Rated insulation voltage (U):

250 V

Overvoltage category:

II

Power supply

Rated supply voltage (U_n):

24 Vac/dc; 50...60 Hz

Max. DC residual ripple in DC:

10%

Supply voltage tolerance:

±15% of U_n

Power consumption AC:

< 5 VA

Power consumption DC:

< 2 W

Control circuit

Protection against short circuits:

PTC resistance, $I_h=0.5 A$

PTC times:

response > 100 ms, reset > 3 s

Maximum resistance per input:

≤ 50 Ω

Current per input:

< 30 mA

Min. duration of start impulse t_{MIN} :

> 100 ms

Response time t_A :

< 85 ms

Release time t_{R1} :

< 40 ms

Release time in absence of power supply t_{R2} :

< 170 ms

Simultaneity time t_C :

unlimited

Output circuit

Output contacts:

4 NO safety contacts

1 NC auxiliary contact

forcibly guided

Contact type:

silver alloy

Material of the contacts:

230/240 Vac; 300 Vdc

Maximum switching voltage:

AC-15 (50 ... 60 Hz), 230 V / 3 A

Utilization categories for output contacts:

DC-13 (6 oper. cycles/min.), 24 V / 4 A

Maximum conventional free air thermal current per branch I_{th} :

6 A

Max. total current ΣI_{th}^2 :

72 A²

Minimum current:

10 mA

Contact resistance:

≤ 100 mΩ

External protection fuse:

4 A

The number and the load capacity of output contacts can be increased by using expansion modules or contactors. See pages 75-84.

Code structure

CS AR-24V024

Start mode

24 manual or automatic start

25 monitored start

Supply voltage

024 24 Vac/dc

Connection type

V Screw terminals

M Connector with screw terminals

X Connector with spring terminals

Features approved by UL

Rated supply voltage (U_n): 24 Vac/dc; 50...60 Hz

Power consumption AC: < 5 VA

Power consumption DC: < 4 W

Electrical ratings:

- NO contacts: 230/240 Vac, 6 A general use, C300 pilot duty

- NC contacts: 230/240 Vac, 6 A resistive, B300 pilot duty

Notes:

- Use 60 or 75°C copper (Cu) conductor and wire size No. 30-12 AWG, stranded or solid.

- The terminal tightening torque of 5-7 lb in.

- Only for 24 Vac/dc versions: supply from remote Class 2 source or limited voltage limited energy.

- Utiliser des conducteurs en cuivre (Cu) ou 75°C rigides ou flexibles de section 30-12 AWG.

- Couple de serrage des bornes de 5-7 lb in.

- Seulement pour les versions 24 Vac/dc, alimenter avec sources de classes 2 ou avec tension limitée et énergie limitée.



Safety module CS AR-24 / CS AR-25

Pin assignment

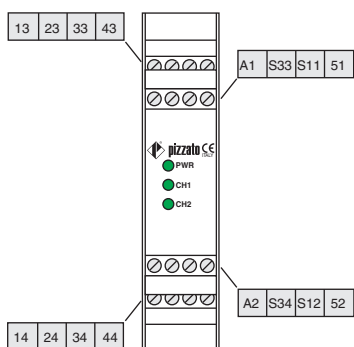

Internal wiring diagram

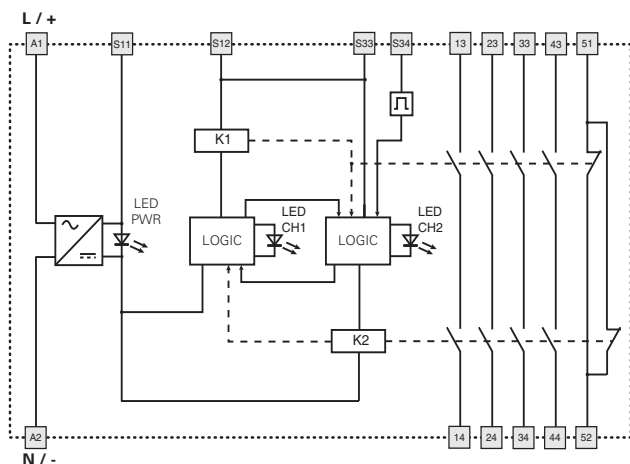

Function diagrams

Configuration with automatic start (CS AR-24 only)

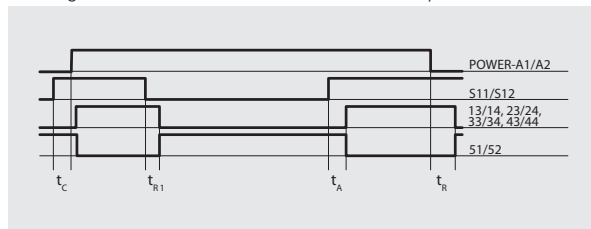

Configuration with monitored start (CS AR-25 only)

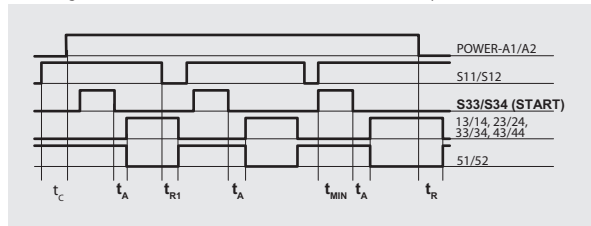

Configuration with manual start (CS AR-24 only)

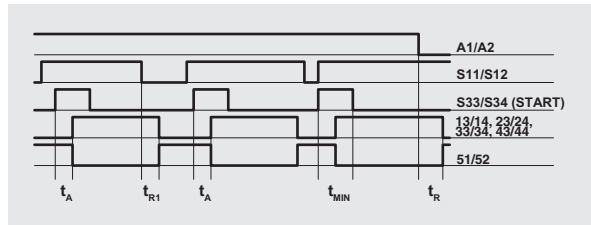

- Legend:
- t_{MIN} : Min. duration of start impulse
 - t_c : Simultaneity time
 - t_A : Response time
 - t_{r1} : Release time
 - t_r : Release time in absence of power supply

Notes:
The configurations with one channel are obtained taking into consideration the S11/S12 input only. In this case it is necessary to consider time t_{r1} referred to input S11/S12, time t_r referred to the supply, time t_A referred to input S11/S12 and to the start, and time t_{MIN} referred to the start.

Input configuration

Emergency stop circuits	
Input configuration with manual start	
1 channel	2 channels

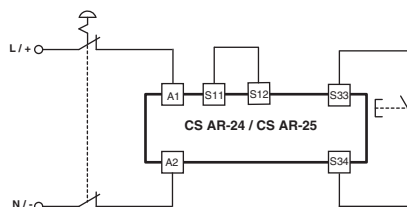
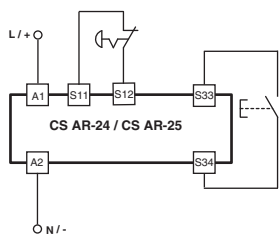

The diagram does not show the exact position of the terminals in the product

Automatic start

With regard to the indicated diagrams, bridge the start button between S33 and S34 in order to activate the automatic start module.

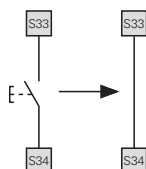

Monitored start

Use module CS AR-25 with the circuit diagrams for manual start.

Movable guard monitoring

The safety module can monitor emergency stop circuits and control circuits for movable guards. Replace the emergency stop contacts with the switch contacts.

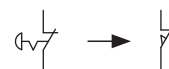

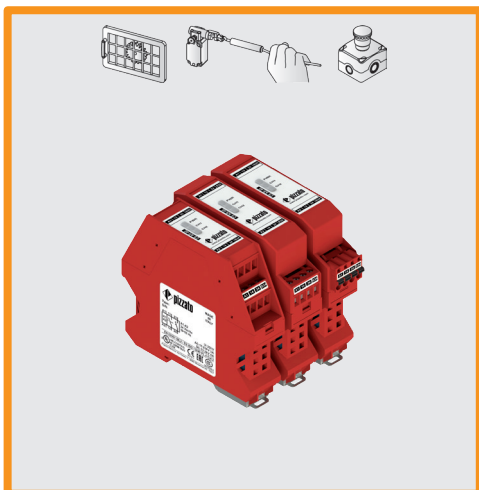

Module for emergency stops and end position monitoring for movable guards

Main features

- For safety applications up to SIL 2/PL d
- Inputs: 1 or 2 channels, which can be connected to electromechanical contacts
- Outputs: relay, 2NO safety
- Input with configurable start: automatic, manual (CS AR-40 only) or monitored (CS AR-41 only)
- Supply voltage: 24 Vac/dc

Quality marks:



EC type examination certificate: IMQ CP 432 DM
 UL approval: E131787
 CCC approval: 2024010305656748
 EAC approval: RU Д-IT.PA07.B.37848/24

Compliance with the requirements of:

Machinery Directive 2006/42/EC,
 EMC Directive 2014/30/EU,
 RoHS Directive 2011/65/EU.

In compliance with standards:

EN 60204-1, EN ISO 13855, EN ISO 14118,
 EN ISO 12100, EN ISO 13850, EN 60529, EN 61000-6-2,
 EN 61000-6-3, EN 61326-1, EN 60664-1, EN 60947-1,
 EN IEC 63000, EN ISO 13849-1, EN ISO 13849-2,
 EN IEC 62061, UL 508, CSA C22.2 No. 14, GB/T14048.5

Technical data

Housing

Polyamide housing PA 66, self-extinguishing V0 acc. to UL 94
 Protection degree acc. to EN 60529: IP40 (housing), IP20 (terminal strip)
 Dimensions: see page 135, design D

General data

Safety Integrity Level (SIL) up to: Maximum SIL 3 acc. to EN 62061
 Performance Level (PL) up to: PL e acc. to EN ISO 13849-1
 Safety category up to: cat. 3 acc. to EN ISO 13849-1
 Safety parameters: See page 151
 Ambient temperature: -25°C...+55°C
 Mechanical endurance: >10 million operating cycles
 Electrical endurance: >100,000 operating cycles
 Pollution degree: external 3, internal 2
 Rated impulse withstand voltage (U_{imp}): 4 kV
 Rated insulation voltage (U): 250 V
 Overvoltage category: II

Power supply

Rated supply voltage (U_n): 24 Vac/dc; 50...60 Hz
 Max. DC residual ripple in DC: 10%
 Supply voltage tolerance: $\pm 15\%$ of U_n
 Power consumption AC: < 5 VA
 Power consumption DC: < 2 W

Control circuit

Protection against short circuits: PTC resistance, $I_h=0.5$ A
 PTC times: response > 100 ms, reset > 3 s
 Maximum resistance per input: $\leq 50 \Omega$
 Current per input: 70 mA (typical)
 Min. duration of start impulse t_{MIN} : > 100 ms
 Response time t_A : < 50 ms
 Release time in absence of power supply t_R : < 150 ms
 Simultaneity time t_c : unlimited

Output circuit

Output contacts: 2 NO safety wire contacts
 Contact type: forcibly guided
 Material of the contacts: silver alloy
 Maximum switching voltage: 230/240 Vac; 300 Vdc
 Utilization categories for output contacts: AC-15 (50 ... 60 Hz), 230 V / 3 A
 DC-13 (6 oper. cycles/min.), 24 V / 4 A
 Maximum conventional free air thermal current per branch I_{th} : 6 A
 Max. total current ΣI_{th}^2 : 36 A²
 Minimum current: 10 mA
 Contact resistance: ≤ 100 m Ω
 External protection fuse: 4 A

The number and the load capacity of output contacts can be increased by using expansion modules or contactors. See pages 75-84.

Code structure

CS AR-40V024

Start mode	
40	manual or automatic start
41	monitored start
Connection type	
V	Screw terminals
M	Connector with screw terminals
X	Connector with spring terminals

Supply voltage	
024	24 Vac/dc

Features approved by UL

Rated supply voltage (U_n): 24 Vac/dc; 50...60 Hz
 Power consumption AC: < 5 VA
 Power consumption DC: < 4 W
 Electrical ratings:
 - NO contacts: 230/240 Vac, 6 A general use, C300 pilot duty
 - NC contacts: 230/240 Vac, 6 A resistive, B300 pilot duty

Notes:

- Use 60 or 75°C copper (Cu) conductor and wire size No. 30-12 AWG, stranded or solid.
- The terminal tightening torque of 5-7 lb in.
- Only for 24 Vac/dc versions: supply from remote Class 2 source or limited voltage limited energy.
- Utiliser des conducteurs en cuivre (Cu) 60 ou 75°C rigides ou flexibles de section 30-12 AWG.
- Couple de serrage des bornes de 5-7 lb In.
- Seulement pour les versions 24 Vac/dc, alimenter avec sources de classes 2 ou avec tension limitée et énergie limitée.



Safety module CS AR-40 / CS AR-41

Pin assignment

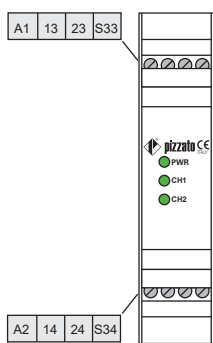

Internal wiring diagram

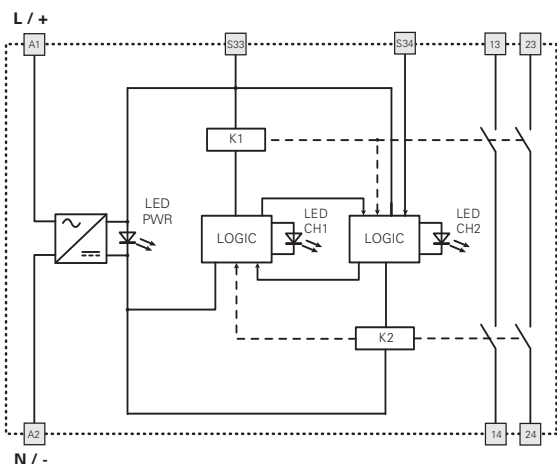

Input configuration

Emergency stop circuits	
Input configuration with manual start	
1 channel	2 channels

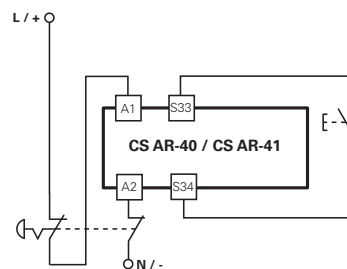
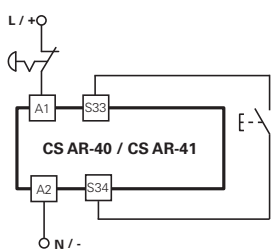

The diagram does not show the exact position of the terminals in the product

Automatic start

With regard to the indicated diagram, bridge the start button between S33 and S34 in order to activate the automatic start module.

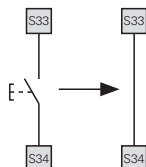

Monitored start

Use module CS AR-41 with the circuit diagrams for manual start.

Movable guard monitoring

The safety module can monitor emergency stop circuits and control circuits for movable guards. Replace the emergency stop contacts with the switch contacts.

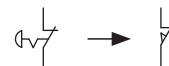

Function diagrams

Configuration with automatic start (CS AR-40 only)

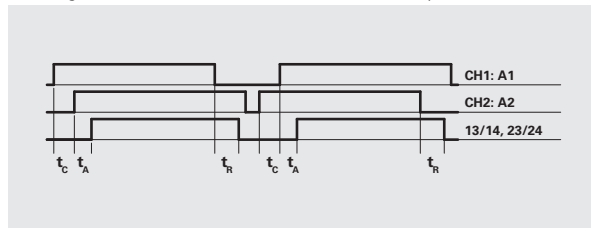

Configuration with monitored start (CS AR-41 only)

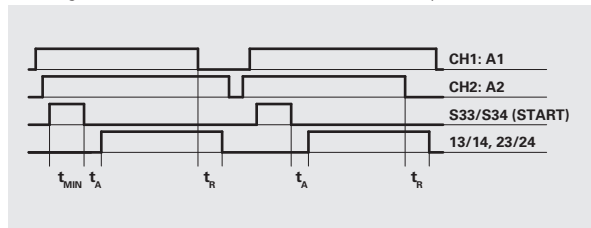

Configuration with manual start (CS AR-40 only)

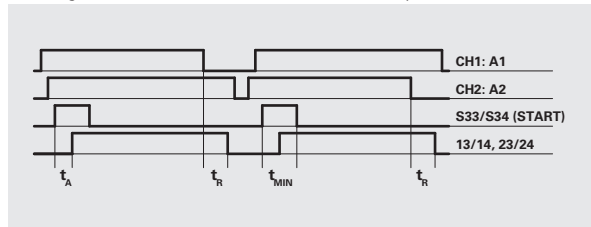

Legend:
 t_{MIN} : Min. duration of start impulse t_A : Response time
 t_c : Simultaneity time t_R : Release time in absence of power supply

Notes:
 The configurations with one channel are obtained taking into consideration the CH1:A1 input only. In this case it is necessary to consider time t_R referred to input CH1:A1, time t_A referred to input CH1:A1 and to the start, and time t_{MIN} referred to the start.

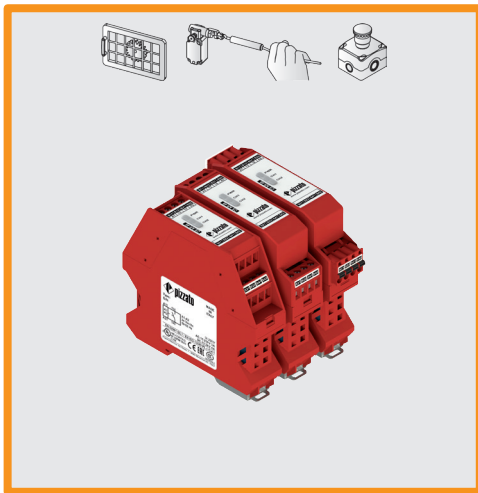

Module for emergency stop, end position monitoring for movable guards, and magnetic safety sensors and devices

Main features

- For safety applications up to SIL 1/PL c
- Inputs: 1 or 2 channels, which can be connected to electromechanical contacts or magnetic safety sensors
- Outputs: relay, 1NO safety
- Supply voltage: 24 Vac/dc

Quality marks:



UL approval: E131787
 CCC approval: 2024010305656748
 EAC approval: RU Д-IT.PA07.B.37848/24

Compliance with the requirements of:

Machinery Directive 2006/42/EC,
 EMC Directive 2014/30/EU,
 RoHS Directive 2011/65/EU.

In compliance with standards:

EN 60204-1, EN ISO 13855, EN ISO 14118,
 EN ISO 12100, EN ISO 13850, EN 60529, EN 61000-6-2,
 EN 61000-6-3, EN 61326-1, EN 60664-1, EN 60947-1,
 EN IEC 63000, EN ISO 13849-1, EN ISO 13849-2,
 EN 62061, UL 508, CSA C22.2 No. 14, GB/T14048.5

Technical data

Housing

Polyamide housing PA 66, self-extinguishing V0 acc. to UL 94
 Protection degree acc. to EN 60529: IP40 (housing), IP20 (terminal strip)
 Dimensions: see page 135, design D

General data

Safety Integrity Level (SIL) up to: Maximum SIL 1 acc. to EN 62061
 Performance Level (PL) up to: PL c acc. to EN ISO 13849-1
 Safety category up to: cat. 1 acc. to EN ISO 13849-1
 Safety parameters: See page 151
 Ambient temperature: -25°C...+55°C
 Mechanical endurance: >10 million operating cycles
 Electrical endurance: >100,000 operating cycles
 Pollution degree: external 3, internal 2
 Rated impulse withstand voltage (U_{imp}): 4 kV
 Rated insulation voltage (U_i): 250 V
 Overvoltage category: II

Power supply

Rated supply voltage (U_n): 24 Vac/dc; 50...60 Hz
 Max. DC residual ripple in DC: 10%
 Supply voltage tolerance: -10% ... +15% of U_n
 Power consumption AC: < 5 VA
 Power consumption DC: < 2 W

Control circuit

Protection against short circuits: PTC resistance, $I_h=0.5$ A
 PTC times: response > 100 ms, reset > 3 s
 Maximum resistance per input: $\leq 50 \Omega$
 Current per input: < 20 mA
 Response time t_A : < 20 ms
 Release time t_{R1} : < 20 ms
 Release time in absence of power supply t_{R2} : < 150 ms
 Simultaneity time t_C : unlimited

Output circuit

Output contacts: 1 NO safety contact
 Material of the contacts: silver alloy
 Maximum switching voltage: 230/240 Vac; 300 Vdc
 Utilization categories for output contacts: AC-15 (50 ... 60 Hz), 230 V / 3 A
 DC-13 (6 oper. cycles/min.), 24 V / 4 A
 Maximum conventional free air thermal current per branch I_{th} : 6 A
 Minimum current: 10 mA
 Contact resistance: ≤ 100 m Ω
 External protection fuse: 4 A

The number and the load capacity of output contacts can be increased by using expansion modules or contactors. See pages 75-84.

Code structure

CS AR-46V024

Connection type	
V	Screw terminals
M	Connector with screw terminals
X	Connector with spring terminals

Supply voltage	
024	24 Vac/dc

Features approved by UL

Rated supply voltage (U_n): 24 Vac/dc; 50...60 Hz
 Power consumption AC: < 5 VA
 Power consumption DC: < 4 W
 Electrical ratings:
 - NO contacts: 230/240 Vac, 6 A general use, C300 pilot duty
 - NC contacts: 230/240 Vac, 6 A resistive, B300 pilot duty

Notes:

- Use 60 or 75°C copper (Cu) conductor and wire size No. 30-12 AWG, stranded or solid.
- The terminal tightening torque of 5-7 lb in.
- Only for 24 Vac/dc versions: supply from remote Class 2 source or limited voltage limited energy.
- Utiliser des conducteurs en cuivre (Cu) 60 ou 75°C rigides ou flexibles de section 30-12 AWG.
- Couple de serrage des bornes de 5-7 Lb In.
- Seulement pour les versions 24 Vac/dc, alimenter avec sources de classes 2 ou avec tension limitée et énergie limitée.



Safety module CS AR-46

Pin assignment

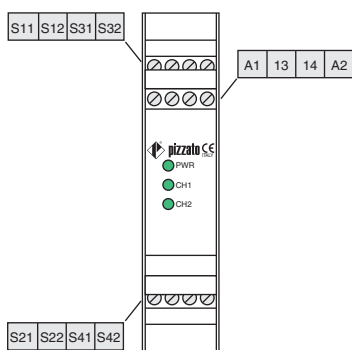

Function diagrams

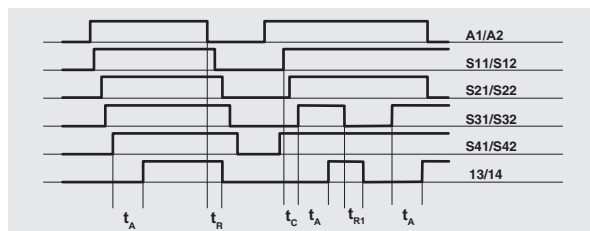

Legend:
 t_C : Simultaneity time
 t_A' : Response time
 t_{R1} : Release time
 t_A'' : Release time in absence of power supply

Internal wiring diagram

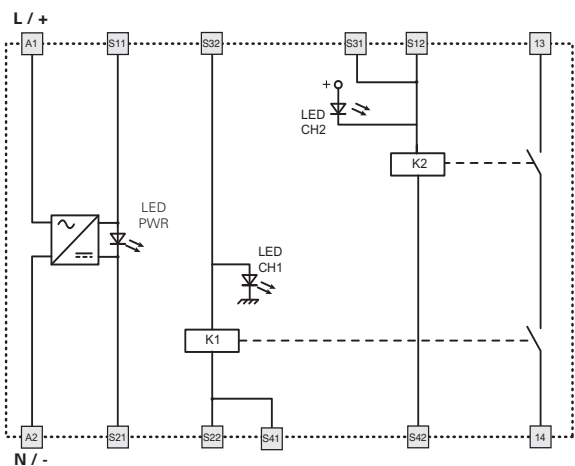

Input configuration

Emergency stop circuits		
Input configuration with automatic start		
2 channels and 1 emergency stop button	2 channels and 2 emergency stop buttons	2 channels and 4 switches

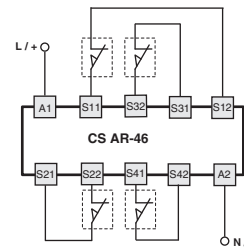
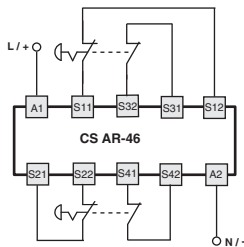
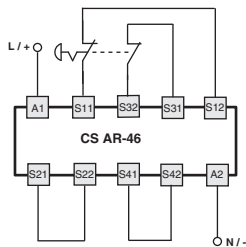

Monitoring of movable guards and magnetic safety sensors

The safety module can monitor emergency stop circuits, control circuits for movable guards as well as magnetic safety sensors. Replace the emergency stop contacts with switch contacts or sensor contacts. The sensors can only be used in 2-channel configuration.

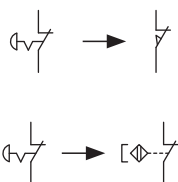

1 channel and 1 emergency stop button

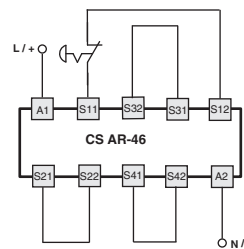

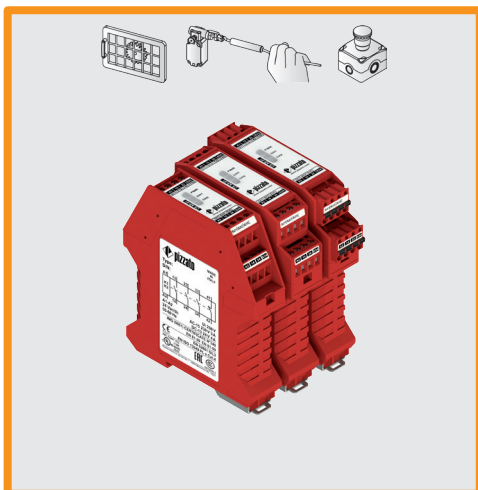

Module for emergency stops, end position monitoring for movable guards and magnetic safety sensors

Main features

- For safety applications up to SIL 3/PL e
- Inputs: 1 or 2 channels, which can be connected to electromechanical contacts or magnetic safety sensors
- Connection of input channels of opposite potentials
- Outputs: relay, 2NO safety, 1NO opto-decoupled signalling
- Input with configurable start: automatic, manual or monitored
- Supply voltage: 24 Vac/dc
- Insensitive to voltage dips

Quality marks:



EU-type examination certificate: IMQ no. 340
(Lift Directive)

EC type examination certificate: IMQ CP 432 DM
(Machinery Directive)

UL approval: E131787

CCC approval: 2024010305656748

EAC approval: RU Д-IT.PA07.B.37848/24

Compliance with the requirements of:

Machinery Directive 2006/42/EC,
EMC Directive 2014/30/EU,
RoHS Directive 2011/65/EU,
Lifts Directive 2014/33/EU

In compliance with standards:

EN 60204-1, EN ISO 13855, EN ISO 14118,
EN ISO 12100, EN ISO 13850, EN 60529, EN 61000-6-2,
EN 61000-6-3, EN 61326-1, EN 60664-1, EN 60947-1,
EN IEC 63000, EN ISO 13849-1, EN ISO 13849-2,
EN 62061, UL 508, CSA C22.2 No. 14,
GB/T14048.5, EN 81-20, EN 81-50

Technical data

Housing

Polyamide housing PA 66, self-extinguishing V0 acc. to UL 94
Protection degree acc. to EN 60529: IP40 (housing), IP20 (terminal strip)
Dimensions: see page 135, design A

General data

Safety Integrity Level (SIL) up to: Maximum SIL 3 acc. to EN 62061
Performance Level (PL) up to: PL e acc. to EN ISO 13849-1
Safety category up to: cat. 4 acc. to EN ISO 13849-1
Safety parameters: See page 151
Ambient temperature: -25°C...+55°C
Mechanical endurance: >10 million operating cycles
Electrical endurance: >100,000 operating cycles
Pollution degree: external 3, internal 2
Rated impulse withstand voltage (U_{imp}): 4 kV
Rated insulation voltage (U_i): 250 V
Overvoltage category: II

Power supply

Rated supply voltage (U_n): 24 Vac/dc; $\pm 15\%$; 50...60 Hz
Max. DC residual ripple in DC: 10%
Power consumption AC: < 5 VA
Power consumption DC: < 2.5 W

Control circuit

Protection against short circuits: PTC resistance, $I_h=0.5 A$
PTC response time: response > 100 ms, reset > 3 s
Maximum resistance per input: $\leq 50 \Omega$
Current per input: < 40 mA
Min. duration of start impulse t_{MIN} : > 50 ms
Response time t_A : < 120 ms
Release time t_{R1} : < 20 ms
Release time in absence of power supply t_R : < 65 ms
Simultaneity time t_C : unlimited
Response time starting from application of the supply: < 300 ms

Auxiliary signalling circuit

Auxiliary output (Y43-Y44): 1NO opto-decoupled
Rated operating voltage (U_o): 24 Vdc
Rated operating current (I_o): 25 mA
Rated impulse withstand voltage (U_{imp}): 4 kV
Release time t_{R2} : < 1 ms

Output circuit

Output contacts: 2 NO safety contacts, forcibly guided
Contact type: silver alloy
Material of the contacts: 230/240 Vac; 300 Vdc
Maximum switching voltage: AC-15 (50 ... 60 Hz), 230 V / 3 A
Utilization categories for output contacts: DC-13 (6 oper. cycles/min.), 24 V / 4 A
Maximum conventional free air thermal current per branch I_{th} : 6 A
Max. total current ΣI_{th}^2 : 36 A²
Minimum current: 10 mA
Contact resistance: $\leq 100 m\Omega$
External protection fuse: 4 A type F

The number and the load capacity of output contacts can be increased by using expansion modules or contactors. See pages 75-84.

Code structure

CS AR-91V024

Connection type

V	Screw terminals
M	Connector with screw terminals
X	Connector with spring terminals

Supply voltage

024 24 Vac/dc

Features approved by UL

Rated supply voltage (U_n): 24 Vac/dc; 50...60 Hz
Power consumption AC: < 5 VA
Power consumption DC: < 4 W

Electrical ratings:

- NO contacts: 230/240 Vac, 6 A general use, C300 pilot duty
- NC contacts: 230/240 Vac, 6 A resistive, B300 pilot duty

Notes:

- Use 60 or 75°C copper (Cu) conductor and wire size No. 30-12 AWG, stranded or solid.
- The terminal tightening torque of 5-7 lb in.
- Only for 24 Vac/dc versions: supply from remote Class 2 source or limited voltage limited energy.

- Utiliser des conducteurs en cuivre (Cu) 60 ou 75°C rigides ou flexibles de section 30-12 AWG.
- Couple de serrage des bornes de 5-7 Lb In.
- Seulement pour les versions 24 Vac/dc, alimenter avec sources de classes 2 ou avec tension limitée et énergie limitée.

Safety module CS AR-91

Pin assignment

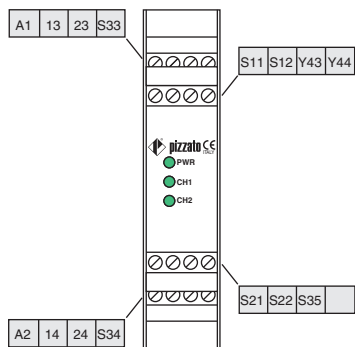

Voltage dips, short interruptions and voltage variations

The CS AR-91 safety module has a built-in voltage drop sensor which serves to protect and safeguard the internal state of the safety relays, in the event of dips or short voltage interruptions. This is to prevent unwanted switching states in relation to the state of the inputs from occurring. When voltage is restored, the device continues to operate with a switching state that is consistent with the input signals. The safety module retains its normal function during voltage dips and brief interruptions; for longer voltage interruptions, the safety outputs open and reset themselves automatically during an automatic start if voltage is restored or – in the case of a manual or monitored start – require that the system be reset by the operator.

Function diagrams

Configuration with automatic start

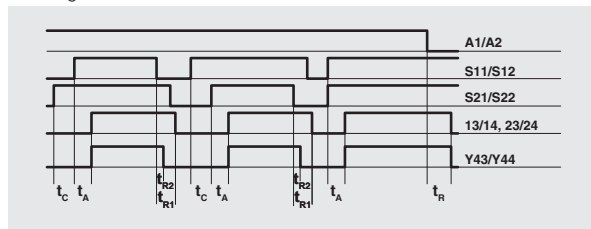

Configuration with monitored start

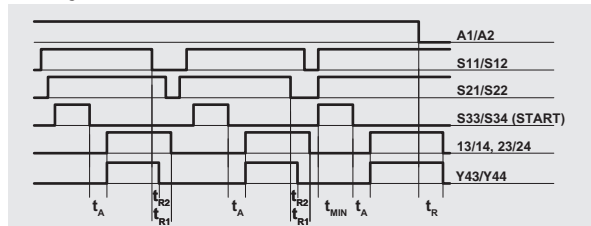

Configuration with manual start

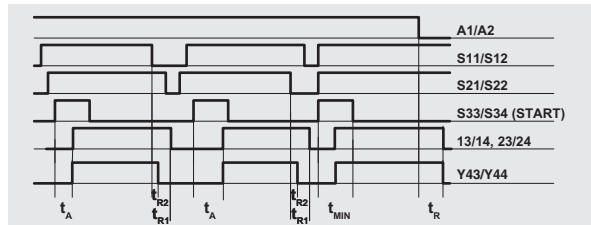

Legend:

- t_{MIN} : Min. duration of start impulse
- t_C : Simultaneity time
- t_A : Response time
- t_{R2} : Release time
- t_{R1} : Release time
- t_{R+} : Release time in absence of power supply

Notes:

The configurations with one channel are obtained taking into consideration the S11/S12 input only. In this case it is necessary to consider time t_{R1} referred to input S11/S12, time t_R referred to the supply, time t_A referred to input S11/S12 and to the start, and time t_{MIN} referred to the start.

Internal wiring diagram

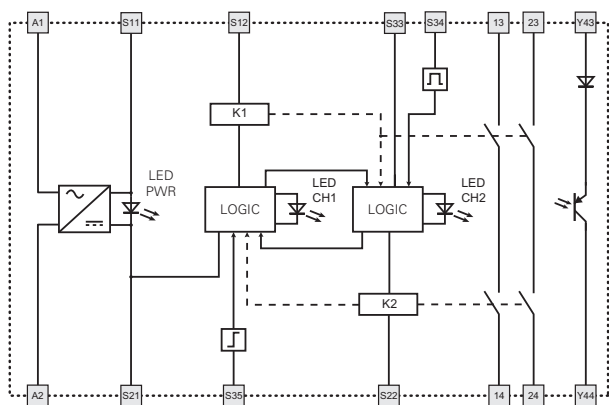

Input configuration

Input configuration with magnetic sensors

2 channels

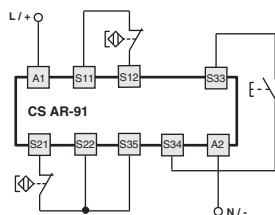

The diagram does not show the exact position of the terminals in the product

Automatic start

With regard to the indicated diagrams, bridge the start button between S33 and S34 in order to activate the automatic start module.

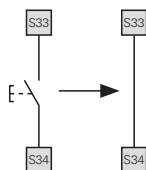

Monitored start

With regard to the indicated diagrams, remove the connection between the S22 and S35 terminals in order to activate the monitored start module.

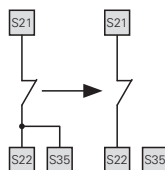

Monitoring of movable guards and magnetic safety sensors

The safety module can monitor emergency stop circuits, control circuits for movable guards as well as magnetic safety sensors. Replace the emergency stop contacts with switch contacts or sensor contacts.

The sensors can only be used in 2-channel configuration.

